

# **GDS-2000**

---

Digital Storage Oscilloscope

GDS-2062

GDS-2064

GDS-2102

GDS-2104

GDS-2202

GDS-2204

## **User Manual**



# Table of Contents

|   |           |
|---|-----------|
| <b>Safety Instructions .....</b>        | <b>5</b>  |
| Safety Symbols .....                    | 6         |
| Safety Guidelines.....                  | 6         |
| Power cord for the United Kingdom ..... | 9         |
| <br>                                    |           |
| <b>Getting Started .....</b>            | <b>11</b> |
| GDS-2000 characteristics.....           | 12        |
| Package Contents .....                  | 13        |
| Power Up.....                           | 14        |
| Functionality check .....               | 15        |
| <br>                                    |           |
| <b>Panel Descriptions .....</b>         | <b>17</b> |
| Front Panel .....                       | 18        |
| Rear Panel .....                        | 21        |
| Display.....                            | 23        |
| <br>                                    |           |
| <b>Quick Reference .....</b>            | <b>25</b> |
| Operation Shortcuts .....               | 26        |
| Menu Tree .....                         | 29        |
| Default Settings .....                  | 38        |
| <br>                                    |           |
| <b>Configure the Settings .....</b>     | <b>39</b> |
| Acquisition.....                        | 41        |
| Cursor.....                             | 45        |
| Display.....                            | 49        |
| Horizontal View .....                   | 54        |
| Vertical .....                          | 56        |
| Other Settings.....                     | 59        |
| Battery Maintenance (Optional) .....    | 63        |

---

|                                      |            |
|--------------------------------------|------------|
| <b>Measurements .....</b>            | <b>64</b>  |
| Automatic Measurements.....          | 65         |
| Go-No Go Test.....                   | 70         |
| Math Operation .....                 | 74         |
| Program and Play .....               | 76         |
| Trigger .....                        | 78         |
| <br>                                 |            |
| <b>Printout/ Data Transfer .....</b> | <b>86</b>  |
| Printout.....                        | 87         |
| Save/ Recall.....                    | 89         |
| <br>                                 |            |
| <b>Remote Control .....</b>          | <b>97</b>  |
| Use PC Software.....                 | 97         |
| Use IEEE based remote control .....  | 102        |
| <br>                                 |            |
| <b>Calibration .....</b>             | <b>114</b> |
| Calibrate the vertical scale .....   | 114        |
| Compensate the probe .....           | 115        |
| <br>                                 |            |
| <b>FAQ .....</b>                     | <b>117</b> |
| <br>                                 |            |
| <b>Appendix.....</b>                 | <b>119</b> |
| Specifications.....                  | 119        |
| Declaration of Conformity .....      | 122        |
| <br>                                 |            |
| <b>Index .....</b>                   | <b>123</b> |

# Safety Instructions

This chapter contains important safety instructions that you must follow when operating GDS-2000 and when keeping it in storage. Read the following before any operation to insure your safety and to keep the best condition for GDS-2000.

---

|                          |   |   |
|--------------------------|---|---|
| <b>Safety Symbols</b>    | Safety Symbols .....                    | 6 |
| <b>Safety Guidelines</b> | General Guideline .....                 | 6 |
|                          | Power Supply .....                      | 7 |
|                          | Fuse .....                              | 7 |
|                          | Cleaning GDS-2000 .....                 | 7 |
|                          | Operation Environment.....              | 8 |
|                          | Storage Environment .....               | 8 |
| <b>Power Up</b>          | Power cord for the United Kingdom ..... | 9 |

---

## Safety Symbols

These safety symbols may appear in this manual or on GDS-2000.



**WARNING**

Warning: Identifies conditions or practices that could result in injury or loss of life.



**CAUTION**

Caution: Identifies conditions or practices that could result in damage to GDS-2000 or to other properties.



DANGER High Voltage



Attention Refer to Manual



Protective Conductor Terminal



Earth (ground) Terminal

## Safety Guidelines

### General Guideline

- Make sure the BNC input voltage does not exceed 300V<sub>peak</sub>.



**CAUTION**

- Never connect a hazardous live voltage to the ground side of the BNC connectors. It might lead to fire and electrical shock.
- Do not place any heavy object on GDS-2000.
- Avoid severe impacts or rough handling that leads to damaging GDS-2000.
- Do not discharge static electricity to GDS-2000.
- Use only mating connectors, not bare wires, for the terminals.
- Do not block or obstruct cooling fan vent

opening.

- Do not perform measurements at power source and building installation site (Note below).
- Do not disassemble GDS-2000 unless you are qualified as service personnel.

---

(Note) EN 61010-1:2001 specifies the measurement categories and their requirements as follows. GDS-2000 falls under category II. Measurement category IV is for measurement performed at the source of low-voltage installation.

Measurement category III is for measurement performed in the building installation.

Measurement category II is for measurement performed on the circuits directly connected to the low voltage installation.

---

#### Power Supply



**WARNING**

- Input voltage: 100 ~ 240 V AC, 48 ~ 63Hz
  - The power supply voltage should not fluctuate more than 10%.
  - Connect the protective grounding conductor of the power cord to earth ground, to avoid electrical shock.
- 

#### Fuse



**WARNING**

- Fuse type: T2A/ 250V
  - Make sure the correct type of fuse is installed before powering up.
  - Replace the fuse with the specified type and rating only, for continued fire protection.
  - Disconnect the power cord before fuse replacement.
  - Make sure the cause of the fuse blowout is fixed before fuse replacement.
- 

#### Cleaning GDS-2000

- Disconnect the power cord before cleaning.
- Use a soft cloth dampened in a solution of mild detergent and water. Do not spray any liquid

into GDS-2000.

- Do not use chemicals or cleaners containing harsh materials such as benzene, toluene, xylene, and acetone.

**Operation Environment**

Location: Indoor, no direct sunlight, dust free, almost non-conductive pollution (Note below)

Relative Humidity: < 80%

Altitude: < 2000m

Temperature: 0°C to 50°C

(Note) EN 61010-1:2001 specifies the pollution degrees and their requirements as follows.

GDS-2000 falls under degree 2.

Pollution refers to “addition of foreign matter, solid, liquid, or gaseous (ionized gases), that may produce a reduction of dielectric strength or surface resistivity”.

Pollution degree 1: No pollution or only dry, non-conductive pollution occurs. The pollution has no influence.

Pollution degree 2: Normally only non-conductive pollution occurs. Occasionally, however, a temporary conductivity caused by condensation must be expected.

Pollution degree 3: Conductive pollution occurs, or dry, non-conductive pollution occurs which becomes conductive due to condensation which is expected. In such conditions, equipment is normally protected against exposure to direct sunlight, precipitation, and full wind pressure, but neither temperature nor humidity is controlled.

**Storage Environment**

Location: Indoor

Relative Humidity: < 80%

Temperature: 0°C to 50°C



## Power cord for the United Kingdom

When using GDS-2000 in the United Kingdom, make sure the power cord meets the following safety instructions.

---

NOTE: This lead / appliance must only be wired by competent persons



WARNING: THIS APPLIANCE MUST BE EARTHED

IMPORTANT: The wires in this lead are coloured in accordance with the following code:

Green/ Yellow: Earth  
Blue: Neutral  
Brown: Live (Phase)



As the colours of the wires in main leads may not correspond with the colours marking identified in your plug/appliance, proceed as follows:

The wire which is coloured Green & Yellow must be connected to the Earth terminal marked with the letter E or by the earth symbol  or coloured Green or Green & Yellow.

The wire which is coloured Blue must be connected to the terminal which is marked with the letter N or coloured Blue or Black.

The wire which is coloured Brown must be connected to the terminal marked with the letter L or P or coloured Brown or Red.

If in doubt, consult the instructions provided with the equipment or contact the supplier.

This cable/appliance should be protected by a suitably rated and approved HBC mains fuse: refer to the rating information on the equipment and/or user instructions for details. As a guide, cable of 0.75mm<sup>2</sup> should be protected by a 3A or 5A fuse. Larger conductors would normally require 13A types, depending on the connection method used.

Any moulded mains connector that requires removal /replacement must be destroyed by removal of any fuse & fuse carrier and disposed of immediately, as a plug with bared wires is hazardous if a engaged in live socket. Any re-wiring must be carried out in accordance with the information detailed on this label.

---



# Getting Started

Follow these instructions to properly setup GDS-2000, especially if you are using it for the first time.

---

|                                     |                                 |    |
|-------------------------------------|---------------------------------|----|
| <b>GDS-2000<br/>Characteristics</b> | Main Features .....             | 12 |
| <b>Package<br/>Contents</b>         | Opening the box .....           | 13 |
|                                     | Contents .....                  | 13 |
| <b>Power Up</b>                     | Tilt stand .....                | 14 |
|                                     | Turn on the Main Power .....    | 14 |
|                                     | Press the ON/ Standby key ..... | 14 |
|                                     | Display view .....              | 14 |
| <b>Functionality<br/>Check</b>      | 1. Connect the Probe.....       | 15 |
|                                     | 2. Capture the signal.....      | 15 |
|                                     | 3. Set the scale .....          | 16 |
|                                     | 4. Compensate the probe.....    | 16 |
|                                     | 5. Start Measurements .....     | 16 |

---

## GDS-2000 characteristics

GDS-2000 is a generic purpose digital storage oscilloscope suitable for wide range of applications such as production testing, research, and field verification.

---

### Main Features

- Wide selection range: 60MHz to 200MHz bandwidth, 2 or 4 channels
  - High Sampling rate: up to 1 GS/s real-time, 25GS/s equivalent-time
  - Powerful display: 5.6 in. color TFT, wide viewing angle, 8 x 12 divisions waveform support
  - USB connection: to printers and storage devices
  - DC Power (battery) operation
  - Deep memory: 25k points record length
  - Automatic measurements: maximum 24 types
  - Peak detection: up to 10ns
  - FFT analysis
  - Triggers: Video, Pulse width, Average, Delay
  - Program and play mode
  - Go-No Go test
  - Built-in help
  - PC software control & IEEE based remote access
-

## Package Contents

Check the contents before using GDS-2000. Contact your local dealer in case there is a missing item.

---

### Opening the box

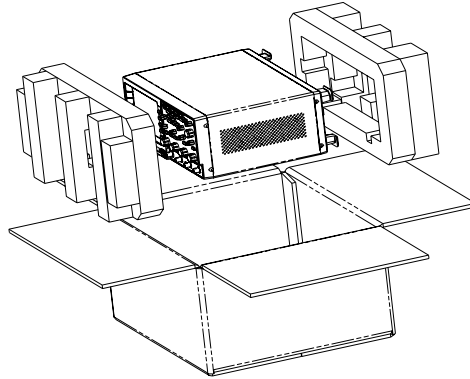

### Contents

#### 1. Main unit

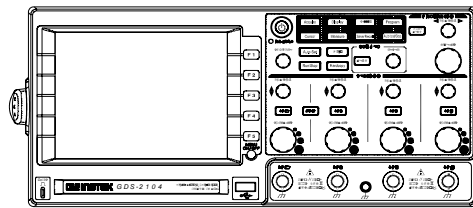

#### 2. Probe set

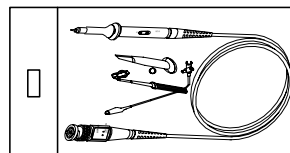

GDS-2062: GTP060A x 2

GDS-2064: GTP060A x 4

GDS-2102: GTP150A x 2

GDS-2104: GTP150A x 4

GDS-2202: GTP250A x 2

GDS-2204: GTP250A x 4

#### 3. Power cord

#### 4. User manual (this document)

---

# Power Up

Place and power up GDS-2000 as follows.

## Tilt stand

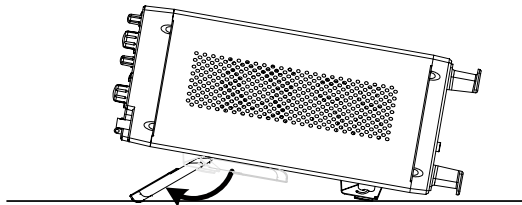

## Turn on the Main Power

1. Connect the Power Cord to the rear panel.
2. Turn ON the Main Power Switch.
3. The ON/STBY indicator on the front panel turns red.

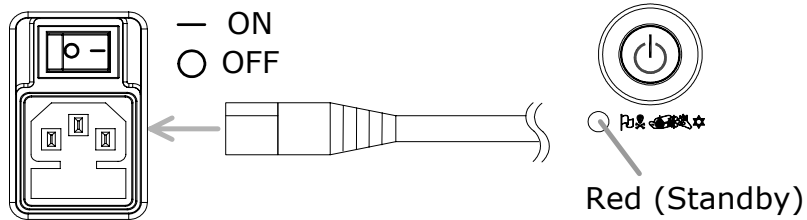

## Press the ON/Standby key

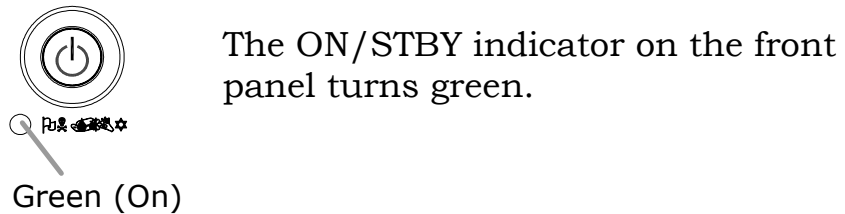

## Display view

The display becomes active in 15~20 seconds.

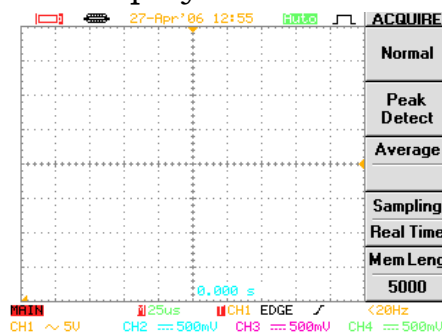

From the second time, the last display setting appears.

## Functionality check

Before operating GDS-2000 in a new environment, run these steps to make sure it is functionally stable.

### 1. Connect the Probe

Connect the probe to Channel1 input terminal and to the probe calibration output (2Vpp±3%, 1kHz square wave).  
Set the probe attenuation scale to x10.

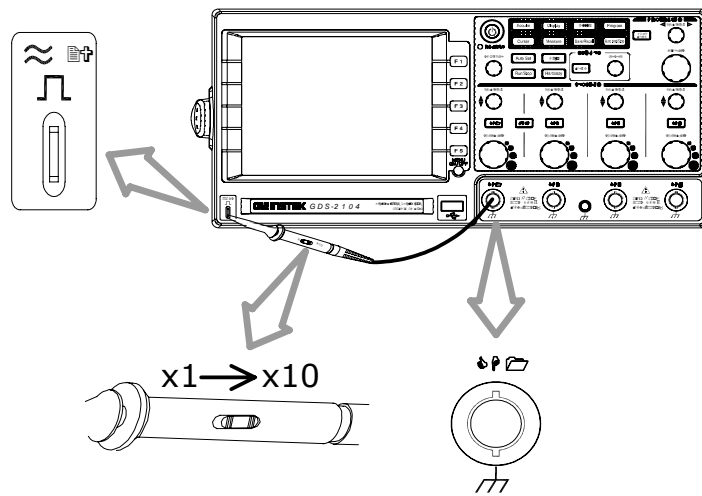

### 2. Capture the signal

Make sure the compensation signal appears. If CH1 is inactive (CH1 key LED is Off), press CH1 key and activate it (LED On).

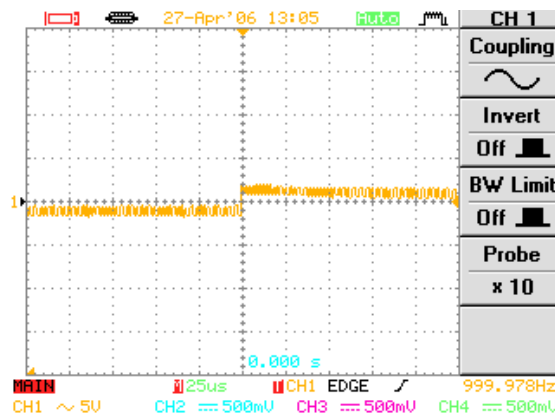

**3. Set the scale**

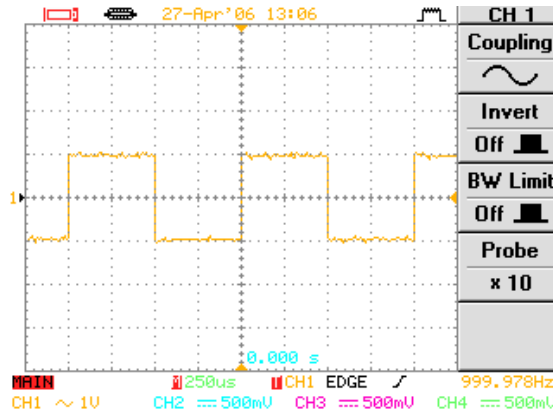

Press Auto Set key . GDS-2000 automatically adjusts the horizontal scale, vertical scale, and trigger level. For Auto Set details, see page65.



Probe compensation signal, 2Vpp, 1kHz

**4. Compensate the probe**

Watch the reference signal edge and compensate the probe accordingly.

To adjust the scale, use Volts/Div knob  (Vertical) and Time/Div knob  (horizontal). For more details, see page115.

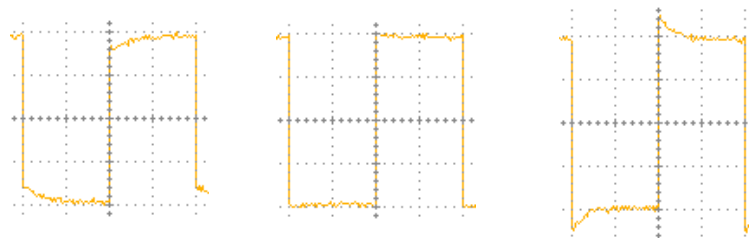

Over Compensation

Normal

Under Compensation

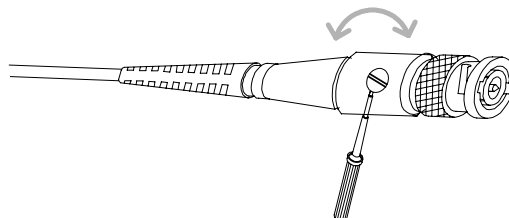

**5. Start Measurements**

Continue with the other measurements. For shortcuts to major operations, see page26. Detailed description starts from page39.



---

# Panel Descriptions

---

---

|                    |   |    |
|--------------------|---|----|
| <b>Front Panel</b> | GDS-2064/ 2104/ 2204 front panel .....                    | 18 |
|                    | GDS-2062/ 2102/ 2202 front panel .....                    | 18 |
|                    | Description of front panel items .....                    | 19 |
| <b>Rear Panel</b>  | GDS-2062/ 2064/ 2102/ 2104/ 2202/ 2204<br>rear panel..... | 21 |
|                    | Description of rear panel items .....                     | 22 |
| <b>Display</b>     | GDS-2062/ 2064/ 2102/ 2104/ 2202/ 2204<br>display .....   | 23 |
|                    | Description of display items .....                        | 23 |

---

# Front Panel

## GDS-2064/ 2104/ 2204 front panel

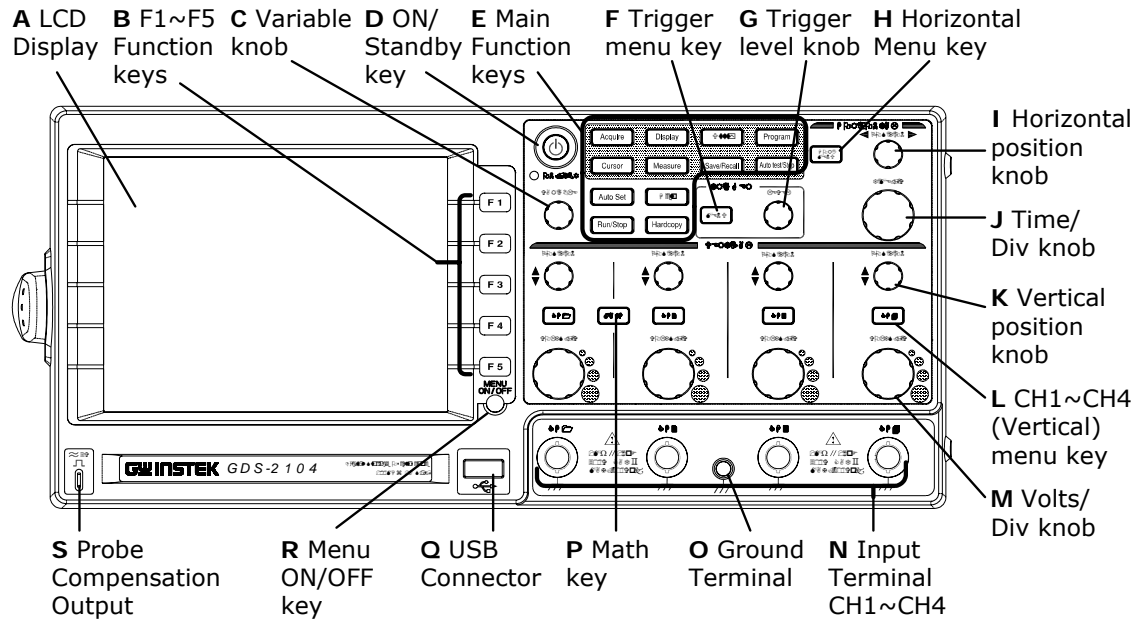

## GDS-2062/ 2102/ 2202 front panel

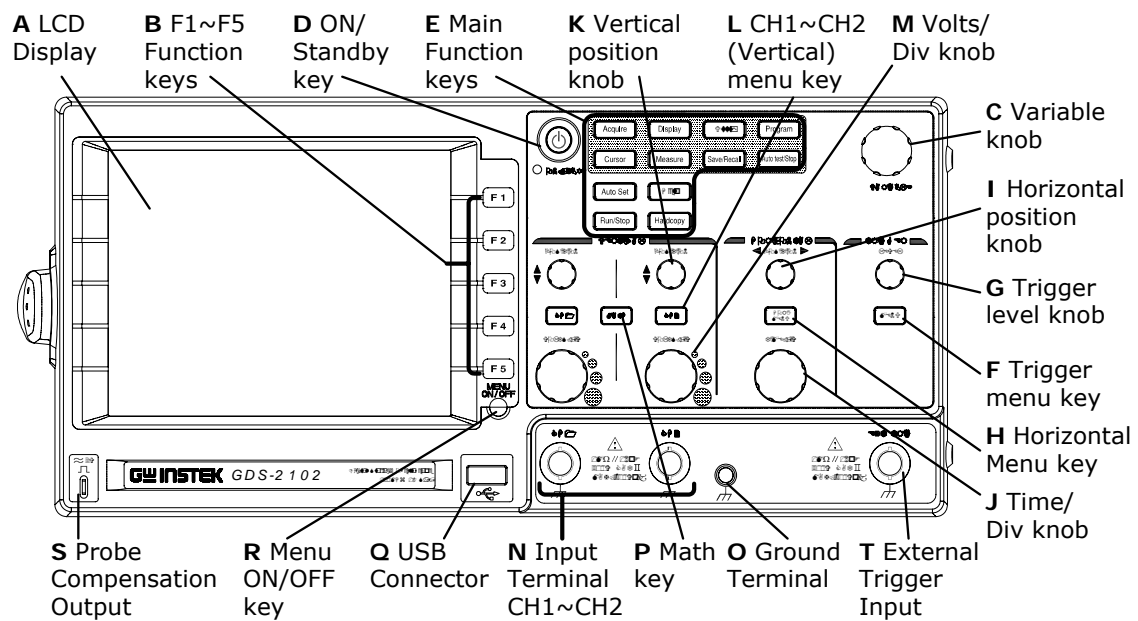

---

 Description of front panel items
 

---

- |   |                         |  |
|---|-------------------------|--|
| A | LCD Display             | TFT Color, 320x234 resolution LCD display.   |
| B | F1 ~F5<br>Function Keys | Soft keys linked to functions shown on the left side of the display.   |
| C | Variable knob           | Clockwise: increases the value or move to the next parameter.<br>Counterclockwise: decreases the value or go back to the previous parameter.   |
| D | On/Standby<br>key       | Press once: Power On (green indicator).<br>Press again: Standby (red indicator).   |
| E | Main Function<br>keys   | <p><b>Acquire key</b> is for configuring acquisition mode. See page41.</p> <p><b>Display key</b> is for configuring display settings. See page49.</p> <p><b>Utility key</b> is for configuring system settings (page59), running Go-No Go test (page70), printout and data transfer together with <b>Hardcopy key</b> (page86), and calibration (page114).</p> <p><b>Program key</b>, together with <b>Auto test/Stop key</b>, are for Program and Play. See page76.</p> <p><b>Cursor key</b> is for configuring horizontal and vertical cursors. See page45.</p> <p><b>Measure key</b> is for configuring and running automatic measurements. See page66.</p> <p><b>Help key</b> is for displaying help contents on the display. See page59.</p> <p><b>Save/Recall key</b> is for saving and recalling image, waveform, and settings between USB and internal memory. See page89.</p> <p><b>Auto Set key</b> is for finding signals and setting scales automatically. See page65.</p> <p><b>Run/Stop key</b> is for freezing the signal view(Stop). See page51.</p> |
| F | Trigger menu<br>key     | For configuring the trigger settings. See page78.  |
| G | Trigger level           | Sets the trigger level: increase (clockwise) or  |

---

|          |                                    |   |
|----------|------------------------------------|---|
|          | <b>knob</b>                        | decrease (counterclockwise).  |
| <b>H</b> | <b>Horizontal menu key</b>         | For configuring the horizontal view. See page54.  |
| <b>I</b> | <b>Horizontal position knob</b>    | Moves the waveform right (clockwise) or left (counterclockwise).                                |
| <b>J</b> | <b>Time/Div knob</b>               | For setting the horizontal scale: fine (clockwise) or coarse (counterclockwise).                |
| <b>K</b> | <b>Vertical position knob</b>      | Moves the waveform upward (clockwise) or downward (counterclockwise).                           |
| <b>L</b> | <b>Channel (Vertical) menu key</b> | For configuring the vertical view for each channel. See page56.                                 |
| <b>M</b> | <b>Volts/Div knob</b>              | For setting the vertical scale for each channel: fine (clockwise) or coarse (counterclockwise). |
| <b>N</b> | <b>Input Terminal</b>              | BNC male connector for signal input.  |
| <b>O</b> | <b>Ground Terminal</b>             | Terminal for connecting the DUT (Device Under Test) ground lead.                                |
| <b>P</b> | <b>Math key</b>                    | For performing Math operations using Channel 1 and 2 input signals. See page74.                 |
| <b>Q</b> | <b>USB connector</b>               | Type A host female, 1.1/ 2.0 compatible. For printing (page87) and data transfer (page89).      |
| <b>R</b> | <b>Menu On/Off key</b>             | Show (On) or hide (Off) the menu from the display. See page53.                                  |
| <b>S</b> | <b>Probe compensation Output</b>   | 2Vpp signal output for probe compensation. See page115.   |
| <b>T</b> | <b>External Trigger Input</b>      | (2CH model only) For external trigger signal used in advanced delay triggering. See page83.     |

---

# Rear Panel

## GDS-2062/ 2064/ 2102/ 2104/ 2202/ 2204 rear panel

- A** Power Switch
- Power Cord** 100V~240V 48Hz~63Hz
- Serial No. Label**
- B** RS232C Connector
- C** GPIB Slot (Optional)
- D** Battery Slot (Optional)

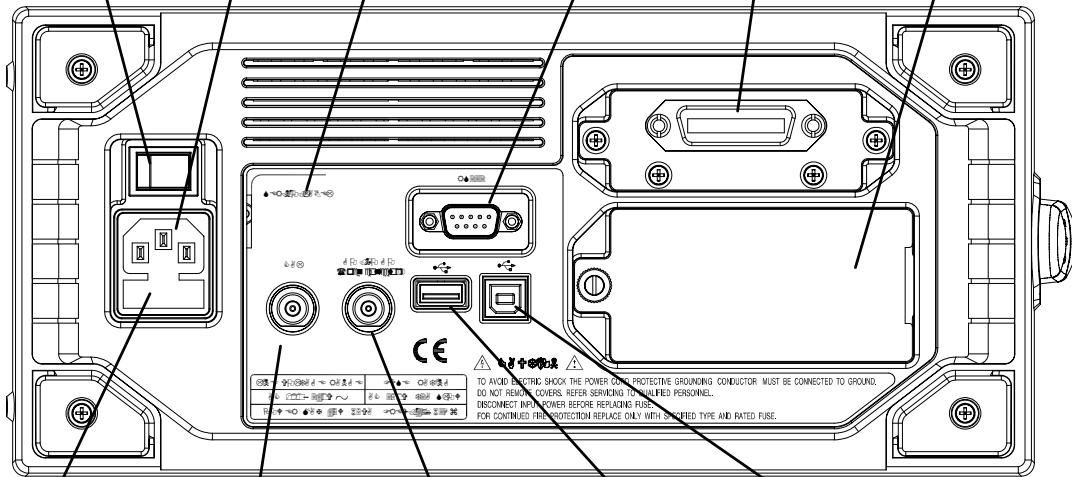

- Fuse** 250V 2A Slow
- H** Calibration Output Terminal
- G** GO-NoGO Output Terminal
- F** USB Host Connector
- E** USB Slave Connector

---

**Description of rear panel items**

---

|                                      |  |
|--------------------------------------|--|
| <b>A Power Switch</b>                | —: ON (front panel indicator turns green)<br>○: OFF (front panel indicator turns red)<br>For power up sequence, see page14.                          |
| <b>B RS232C Connector</b>            | 9 pin male connector used for IEEE based remote control. See page102.  |
| <b>C GPIB Slot (Optional)</b>        | 24 pin female connector used for IEEE based remote control. See page102.   |
| <b>D Battery Slot (Optional)</b>     | 10.8V Li-Ion battery pack, 12h charging time/ 3h operation time. See page63.   |
| <b>E USB Slave Connector</b>         | Type B slave female connector used for PC software connection (page97) and IEEE based remote control (page102).                                      |
| <b>F USB Host Connector</b>          | Type A host female, 1.1/2.0 compatible. Has the same functionality as the front panel USB connector. (NOT allowed to use them both at the same time) |
| <b>G Go-NoGo Output Terminal</b>     | Outputs Go-NoGo test result as a pulse signal. See page70.   |
| <b>H Calibration Output Terminal</b> | Outputs signal used in calibrating GDS-2000. See page114.  |

---

# Display

## GDS-2062/ 2064/ 2102/ 2104/ 2202/ 2204 display

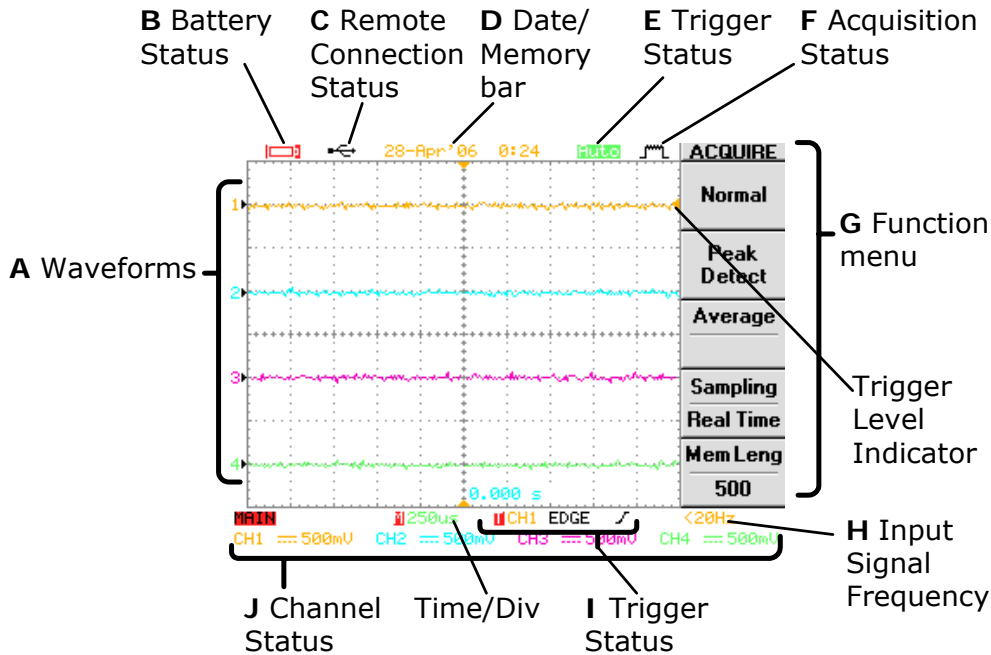



### Description of display items

- |                                    |  |
|------------------------------------|--|
| <b>A Waveforms</b>                 | Input signal waveforms, activated by pressing the Channel key.<br><br>Channel1: Amber      Channel2: Blue<br>Channel3: Pink      Channel4: Green   |
| <b>B Battery Status (Optional)</b> | Indicates the remaining battery level, when the battery is installed.  |
| <b>C Remote Connection Status</b>  | The active interface for PC software/ Remote control.<br><ul style="list-style-type: none"> <li>☐: RS232C is active</li> <li>☐: USB is active</li> <li>☐: GPIB (optional) is active</li> </ul> |
| <b>D Date/ Memory bar</b>          | 28-Apr '06 0:24 : (Default) The current time and date, configured in the Utility menu. See page61.   |

- E Trigger Status**



 The memory bar temporary appears when configuring the horizontal scale (page54), memory length (page43), and zoom (page54), indicating the ratio and the position of display waveform compared with the internally stored information.

Auto: Trigger level is automatically adjusted  
None: Trigger condition is not found  
STOP: Triggering is halted  
 For triggering details, see page78.
  - F Acquisition Status**

: Normal mode  
: Peak Hold mode  
: Average mode  
 For acquisition details, see page41.
  - G Function key**

The active function key and menu corresponding to F1~F5 soft keys.
  - H Input Signal Frequency**

The signal frequency of the selected channel. <20Hz shows the frequency is less than 20Hz.
  - I Trigger Status**

T CH1 EDGE 

(From left) Trigger source channel, trigger type, and slope  
 For trigger details, see page78.
  - J Channel Status**

CH1  ~ 500mV

(From left) Channel, Bandwidth limit, Coupling mode, Time/Div scale  
 For Channel (vertical scale) details, see page56.
-



---

# Quick Reference

---

|                            |   |    |
|----------------------------|---|----|
| <b>Operation Shortcuts</b> | Configure the System.....               | 26 |
|                            | Measure the Signal .....                | 27 |
|                            | Print and Data Transfer.....            | 27 |
|                            | Remote Control .....                    | 28 |
|                            | Calibration .....                       | 28 |
| <b>Menu Tree</b>           | Acquire, Channel, Cursor, Display.....  | 29 |
|                            | Horizontal, Math, Measure (1 of 2)..... | 30 |
|                            | Measure (2 of 2), Program .....         | 31 |
|                            | Save/ Recall (1 of 2) .....             | 32 |
|                            | Save/ Recall (2 of 2) .....             | 33 |
|                            | Trigger .....                           | 34 |
|                            | Utility (1 of 3) .....                  | 35 |
|                            | Utility (2 of 3) .....                  | 36 |
|                            | Utility (3 of 3) .....                  | 37 |
| <b>Default Settings</b>    | Default Settings .....                  | 38 |

---

## Operation Shortcuts

Here is the list of operations introduced in this manual and their key shortcuts.

### Symbols description

---

|            |   |
|------------|---|
| Display→F1 | =Press the Display key, then press F1                 |
| F1↵        | =Press F1 repeatedly, if necessary                    |
| F1~F4      | =Use all F1, F2, F3, and F4 to complete the operation |

### Configure the System

---

#### Acquisition

|                             |               |
|-----------------------------|---------------|
| Select the Acquisition mode | Acquire→F1~F4 |
| Select the memory length    | Acquire→F5    |

#### Cursor

|                              |               |
|------------------------------|---------------|
| Select the horizontal cursor | Cursor→F1~F2  |
| Select the vertical cursor   | Cursor→F1, F3 |

#### Display

|                                  |             |
|----------------------------------|-------------|
| Freeze the waveform              | Run/Stop    |
| Refresh the display view         | Display→F3  |
| Select the display grid          | Display→F5  |
| Select the vectors/dots waveform | Display→F1  |
| Set the display contrast         | Display→F4  |
| Turn Off the display menu        | Menu ON/OFF |
| View accumulated waveform        | Display→F2  |

#### Horizontal

|                          |                |
|--------------------------|----------------|
| Zoom the horizontal view | HORIMENU→F2~F3 |
| Roll the horizontal view | HORIMENU→F4    |
| View in XY mode          | HORIMENU→F5    |

#### Vertical

|                               |              |
|-------------------------------|--------------|
| Invert the waveform           | CH1/2/3/4→F2 |
| Limit the frequency bandwidth | CH1/2/3/4→F3 |
| Select the coupling mode      | CH1/2/3/4→F1 |
| Select the probe attenuation  | CH1/2/3/4→F4 |

#### Other Configurations

|                         |            |
|-------------------------|------------|
| Select the buzzer sound | Utility→F3 |
|-------------------------|------------|

|                             |                      |
|-----------------------------|----------------------|
| Select the language         | Utility→F4           |
| Set the date/time           | Utility→F5→F5→F2→F1↵ |
| View the system information | Utility→F5→F2        |

**Measure the Signal**

**Automatic Measurements**

|                                  |                       |
|----------------------------------|-----------------------|
| Delay automatic measurements     | Measure→F5→F3↵        |
| Set the scale automatically      | Auto Set              |
| Time automatic measurements      | Measure→F3→F3↵        |
| View all the measurement results | Measure→Measure→F1~F4 |
| Voltage automatic measurements   | Measure→F1→F3↵        |

**Go-No Go Test**

|                             |  |
|-----------------------------|--|
| Edit Go-No Go test template | Utility→F3→F2~F3<br>Utility→F3→F1→F1~F4<br>Utility→F5→F4 |
| Run Go-No Go test           | Utility→F5→F3→F4   |

**Math Operation**

|                                 |                |
|---------------------------------|----------------|
| Add/ Subtract/ Multiply/ Divide | MATH→F1↵→F2~F4 |
| Run FFT operation               | MATH→F1↵→F2~F5 |

**Program and Play**

|                        |                   |
|------------------------|-------------------|
| Edit the program steps | Program→F1↵→F2~F5 |
| Play the program       | Program→F1↵→F2~F5 |

**Trigger**

|                         |                            |
|-------------------------|----------------------------|
| Use Delay trigger       | Trigger→F1↵→F2~F4→F5→F1~F4 |
| Use Edge trigger        | Trigger→F1↵→F2~F3→F5→F1~F4 |
| Use Pulse width trigger | Trigger→F1↵→F2~F4→F5→F1~F4 |
| Use Video trigger       | Trigger→F1↵→F2~F5          |

**Print and Data Transfer**

**Printout**

|                                 |                            |
|---------------------------------|----------------------------|
| Printout display image/waveform | Utility→F1↵→F1<br>Hardcopy |
|---------------------------------|----------------------------|

**Save and Recall**

|                                 |                           |
|---------------------------------|---------------------------|
| Quick save to USB               | Utility→F1→F1<br>Hardcopy |
| Save all (image/setup/waveform) | Save/Recall→F5→F2→F1~F4   |
| Save image                      | Save/Recall→F5→F1→F1~F4   |

|                                 |                         |
|---------------------------------|-------------------------|
| Save setup                      | Save/Recall→F3→F1~F4    |
| Save waveform                   | Save/Recall→F4→F1~F4    |
| Recall setup                    | Save/Recall→F5→F3→F1~F4 |
| Recall waveform                 | Save/Recall→F5→F4→F1~F4 |
| Configure folders in USB memory | Save/Recall→F3→F5→F1~F4 |

### Remote Control

---

|                         |                |
|-------------------------|----------------|
| Configure the interface | Utility→F2→F1↩ |
|-------------------------|----------------|

### Calibration

---

|                      |                        |
|----------------------|------------------------|
| Calibrate GDS-2000   | Utility→F5→F1→F1~F3    |
| Compensate the probe | Utility→F5→F5→F1→F1~F3 |

## Menu Tree

No menu for the following keys: Auto Set, Run/Stop, Help, Auto test/Stop, Hardcopy.

### Acquire, Channel, Cursor, Display

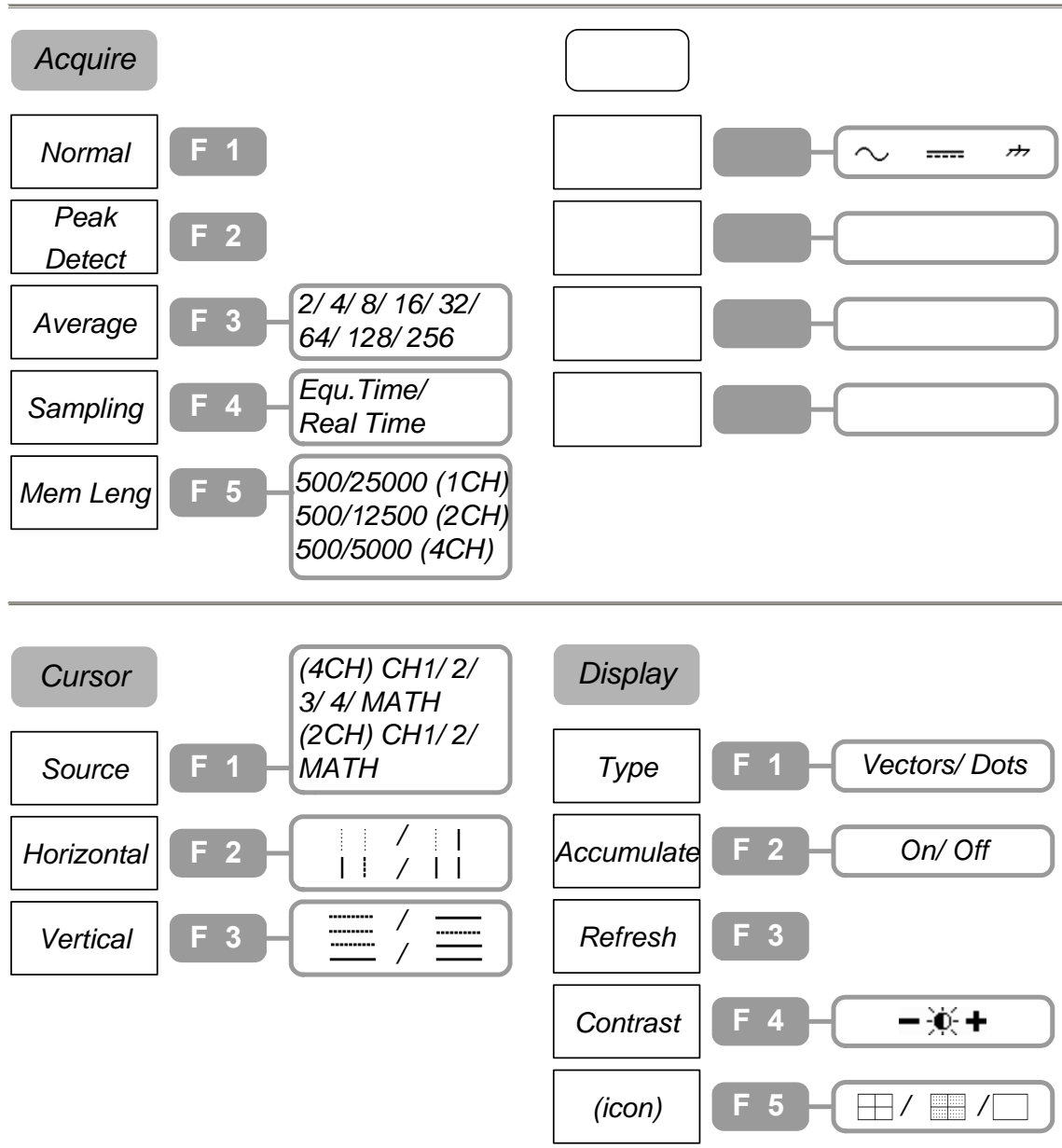

**Horizontal, Math, Measure (1 of 2)**

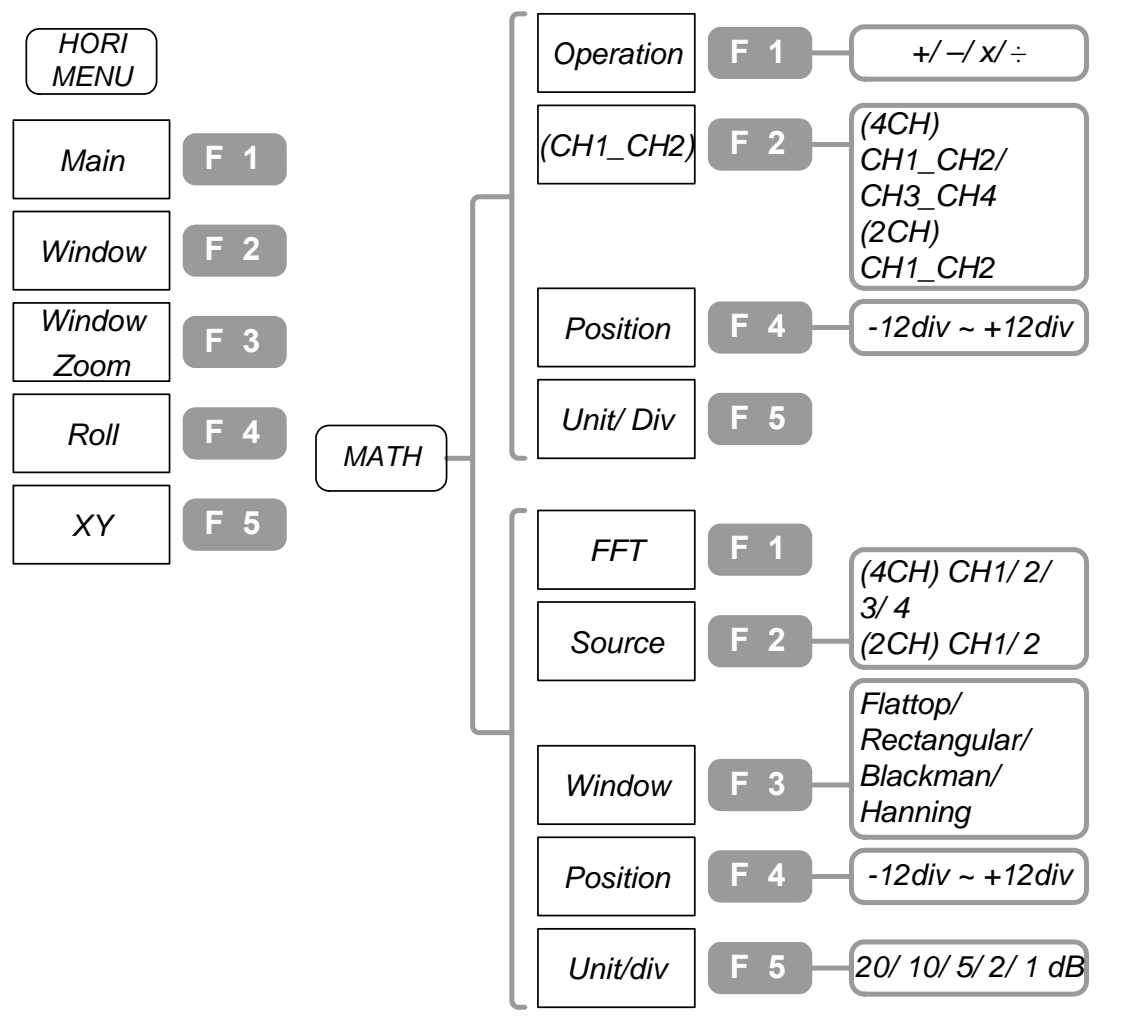

(Press once)

(Press twice)

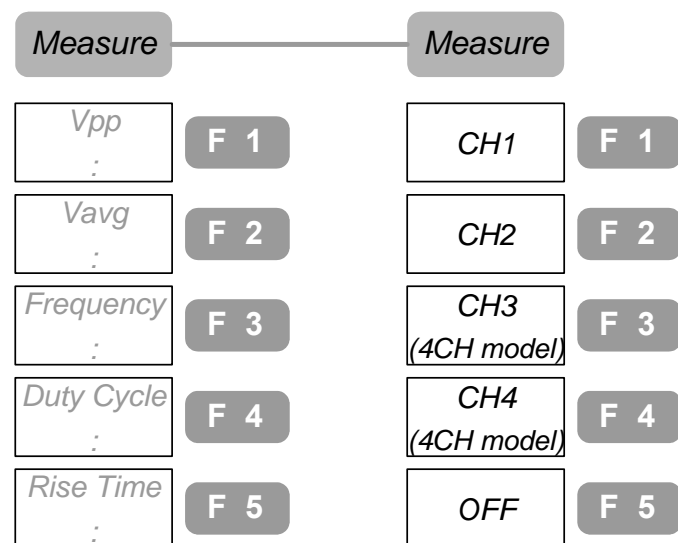

**Measure (2 of 2), Program**

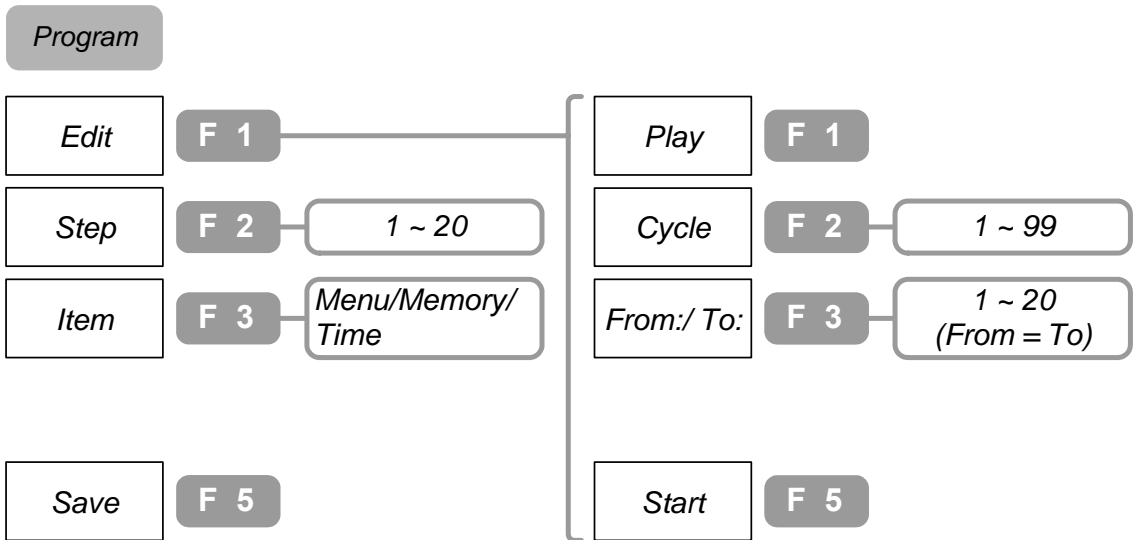
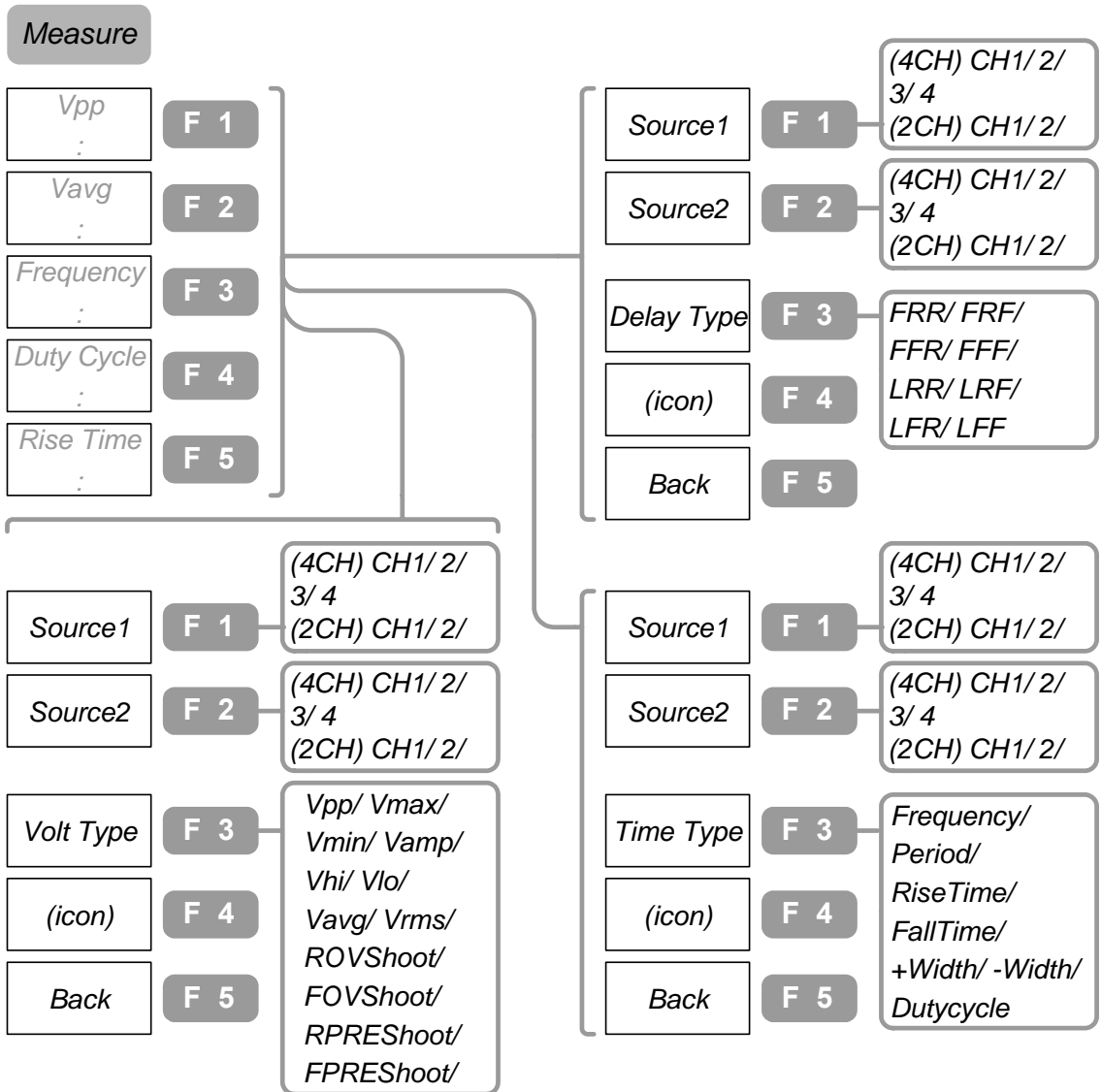

Save/ Recall (1 of 2)

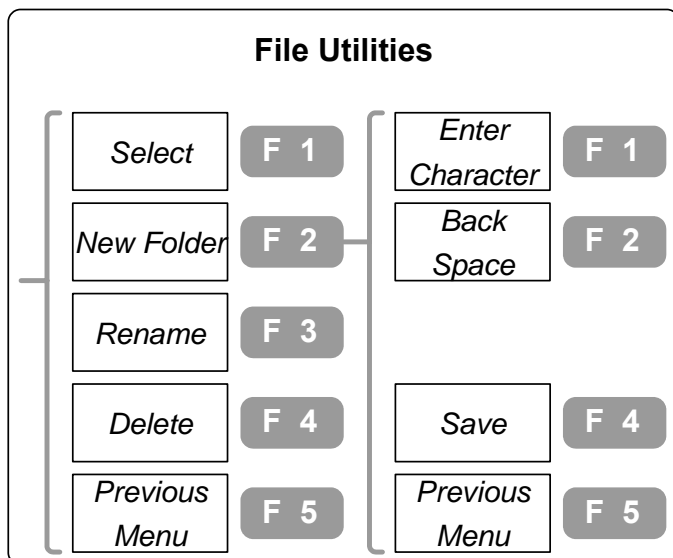
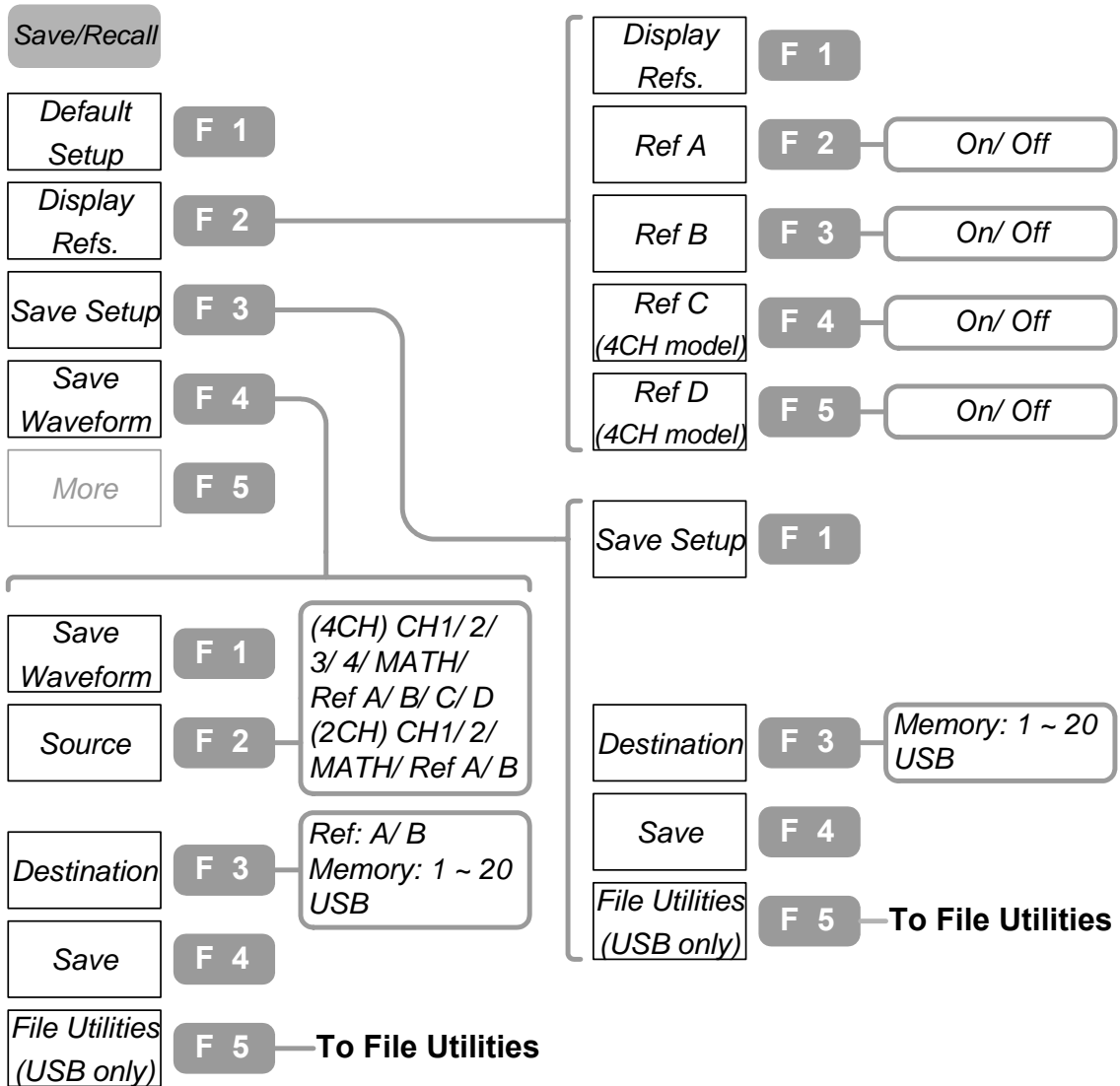



**Save/ Recall (2 of 2)**

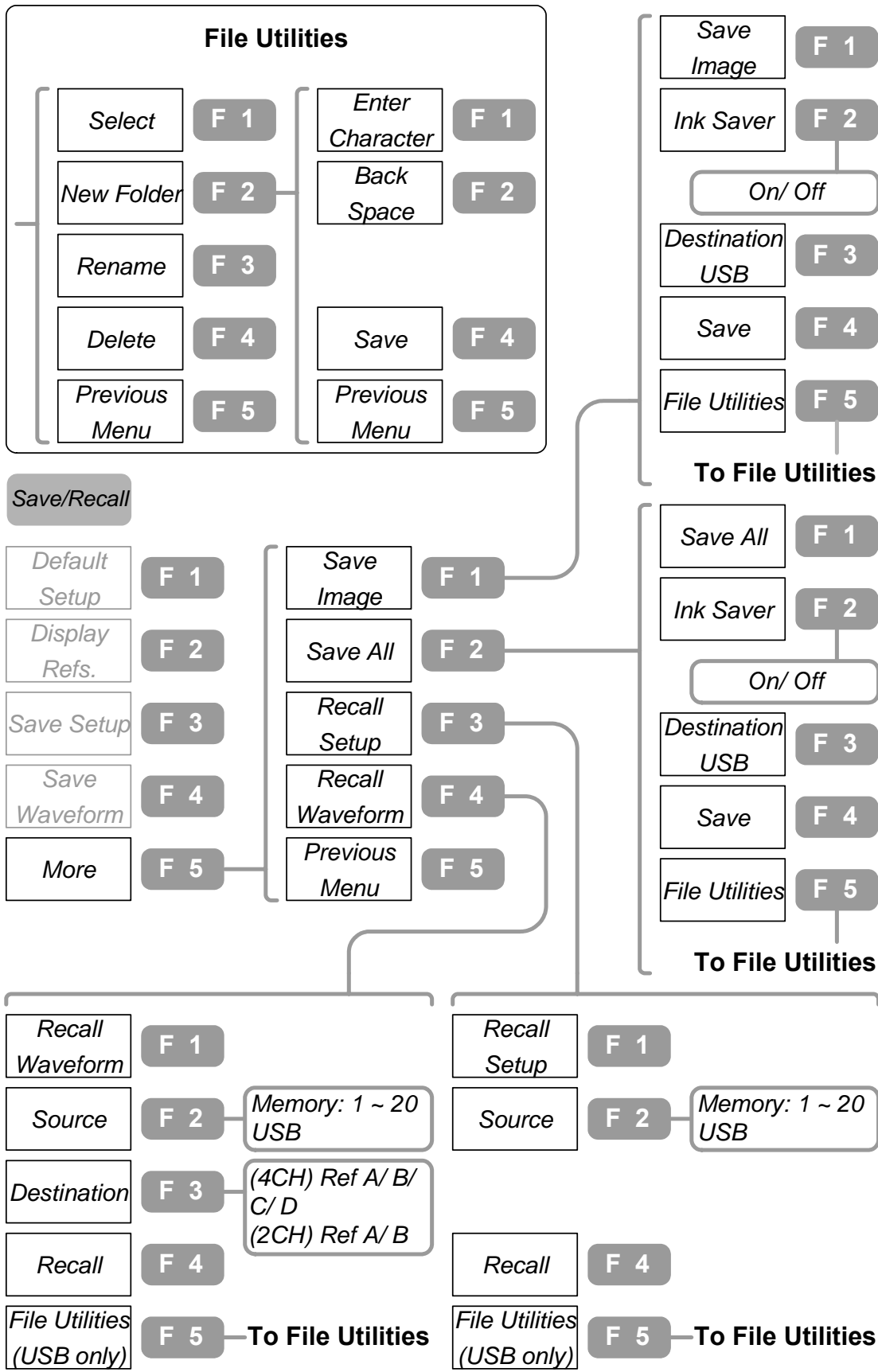

Trigger

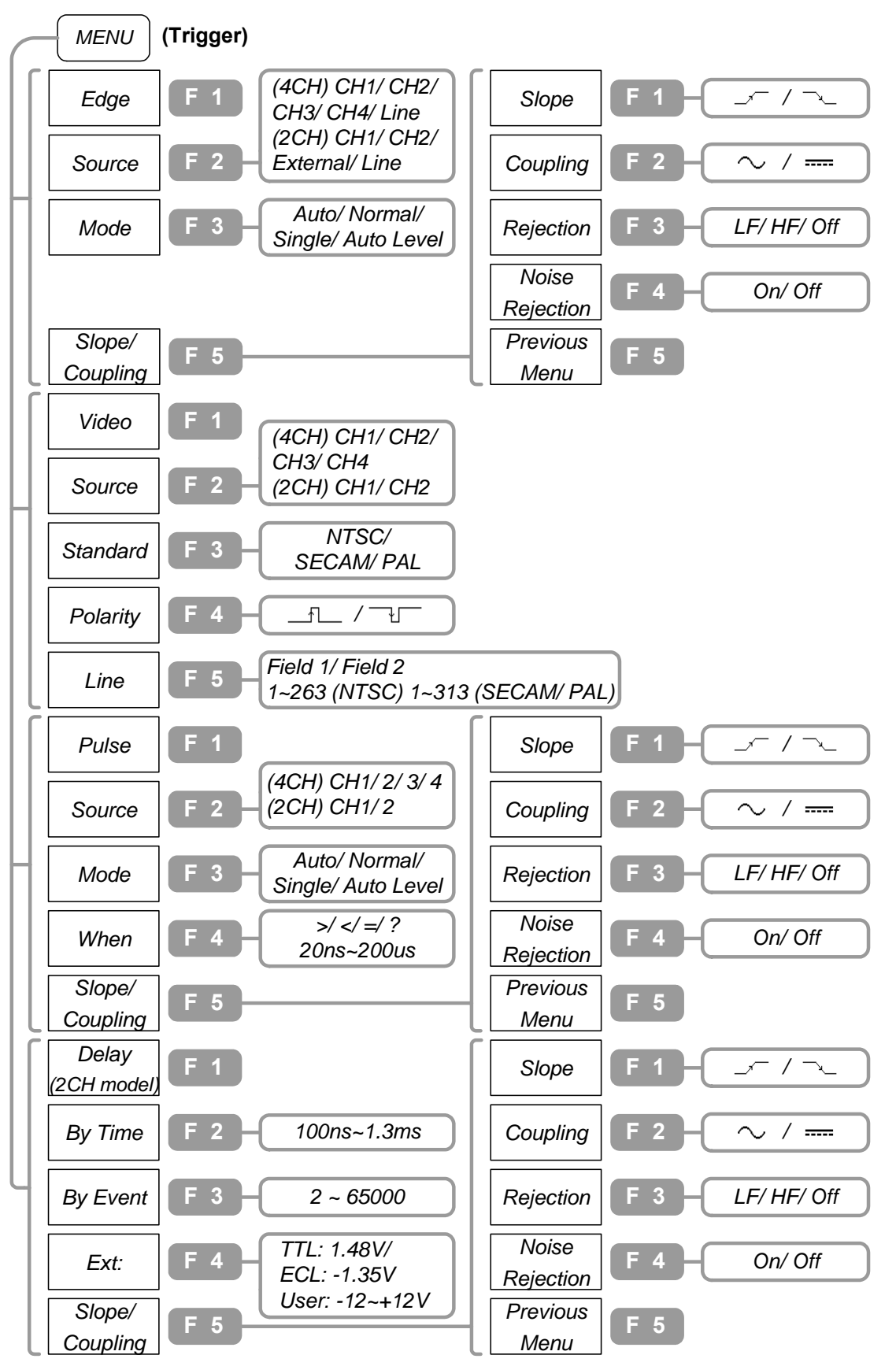

**Utility (1 of 3)**

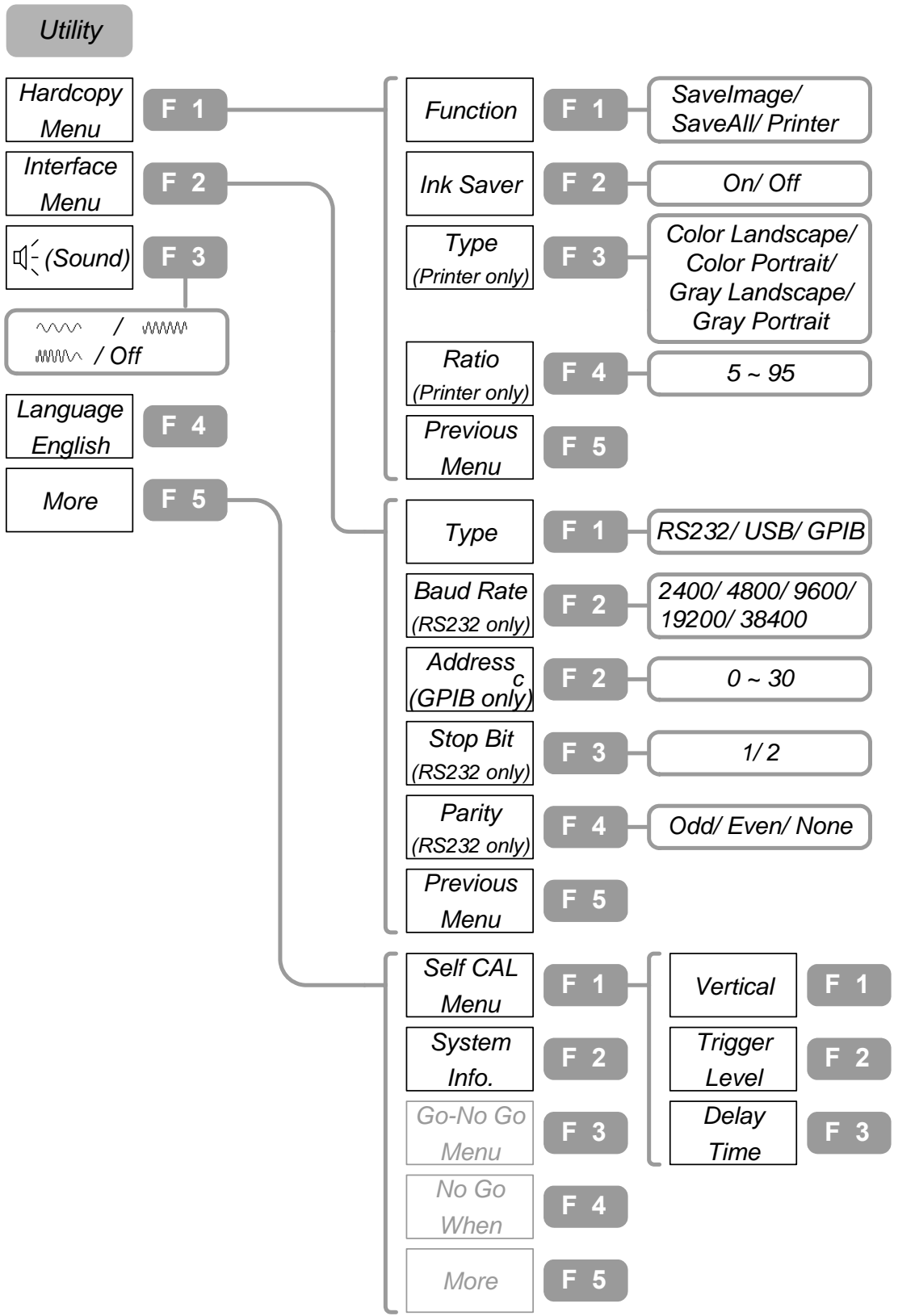

**Utility (2 of 3)**

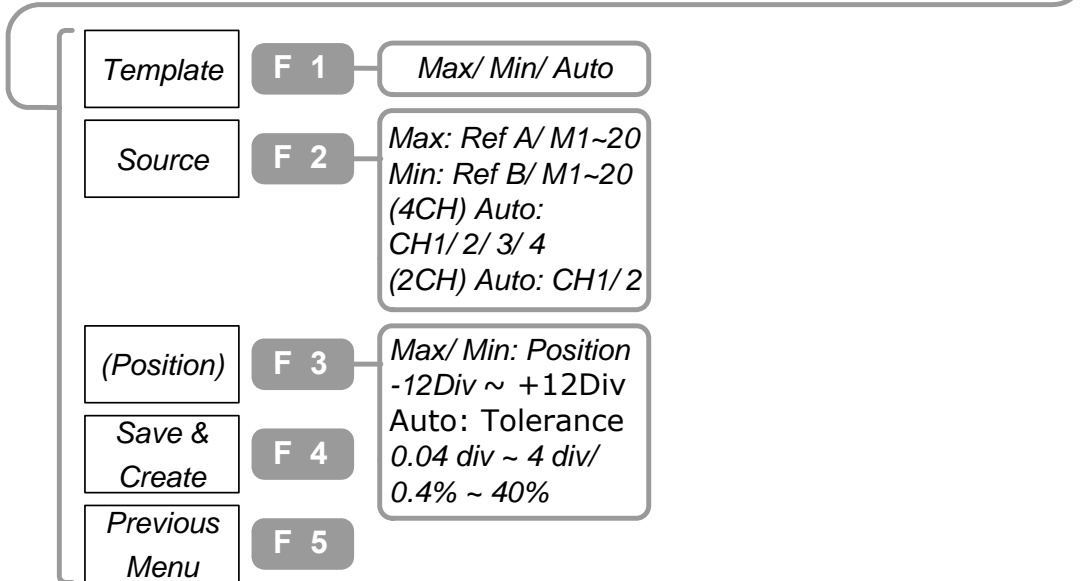
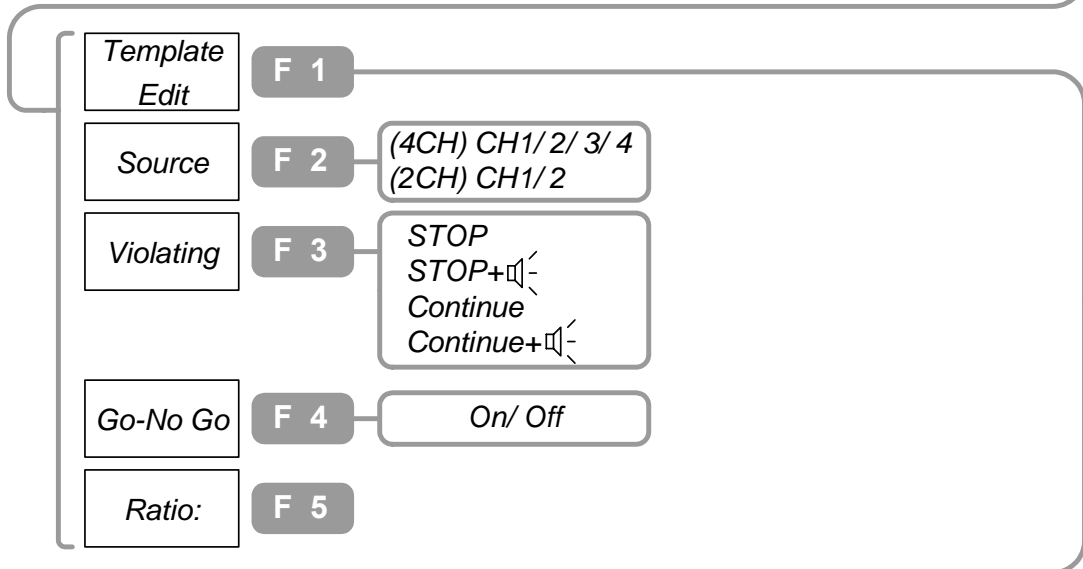
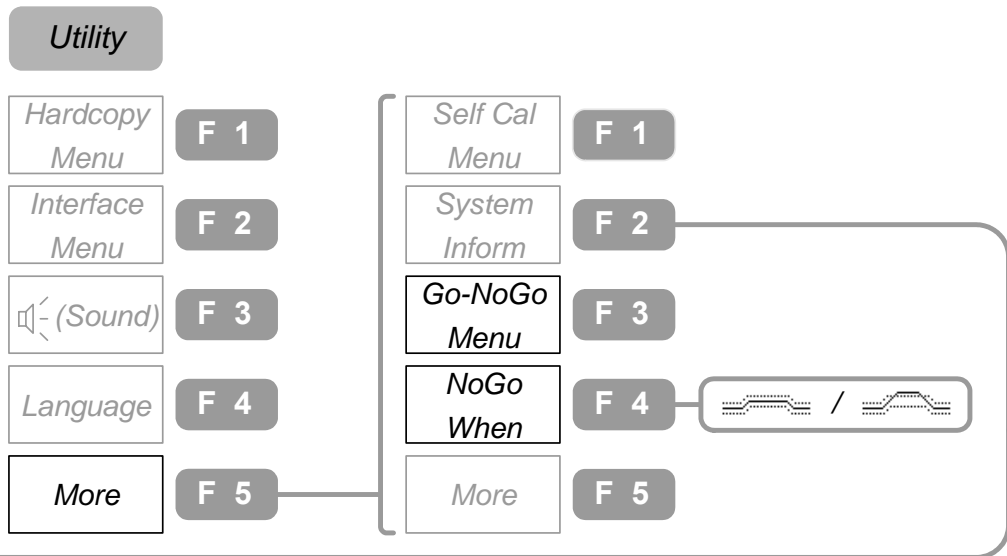



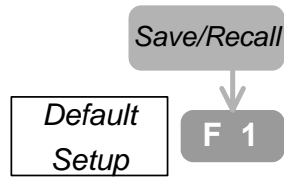

## Default Settings



These are the factory installed settings that appear when pressing Save/Recall key→F1 (Default Setup).

|                           |  |  |
|---------------------------|--|--|
| <b>Acquisition</b>        | Mode: Normal   | Memory Length: 500   |
| <b>Channel (Vertical)</b> | Scale: 2V/Div<br>Coupling: DC<br>BW Limit: Off   | Invert: Off<br>Probe Attenuation: x1   |
| <b>Cursor</b>             | Source: CH1<br>Vertical: None  | Horizontal: None   |
| <b>Display</b>            | Type: dots<br>Graticule:     | Accumulate: Off  |
| <b>Go-NoGo</b>            | Go-NoGo: Off<br>NoGo when:  | Source: CH1<br>Violating: Stop   |
| <b>Horizontal</b>         | Scale: 2.5us/Div   | Mode: Main Timebase  |
| <b>Math</b>               | Type: +<br>Position: 0.00 Div  | Channel: CH1+CH2<br>Unit/Div: 2V   |
| <b>Measure</b>            | Source1: CH1<br>Volt type: VPP<br>Delay type: FRR  | Source2: CH2<br>Time Type: Frequency   |
| <b>Program</b>            | Mode: Edit<br>Item: Memory   | Step: 1  |
| <b>Trigger</b>            | Type: Edge<br>Mode: Auto<br>Coupling: DC<br>Noise Rejection : Off  | Source: Channel1<br>Slope: <br>Rejection: Off |
| <b>Utility</b>            | Hardcopy: SaveImage,<br>Inksaver Off<br>Sound: Off   | Interface: GPIB,<br>Address 8  |

---

# Configure the Settings

---

|                        |   |    |
|------------------------|---|----|
| <b>Acquisition</b>     | Select the Acquisition mode .....                                     | 41 |
|                        | Select the waveform memory length .....                               | 43 |
|                        | Relationship between Sampling rate, Memory length, and Timebase ..... | 44 |
| <b>Cursor</b>          | Select the horizontal cursor type .....                               | 45 |
|                        | Select the vertical cursor type .....                                 | 47 |
| <b>Display</b>         | Select the vector/dot waveform .....                                  | 49 |
|                        | View accumulated waveform .....                                       | 50 |
|                        | Set the display contrast .....  | 51 |
|                        | Freeze the waveform .....   | 51 |
|                        | Select the display grid type .....                                    | 52 |
|                        | Turn Off the display menu .....                                       | 53 |
| <b>Horizontal View</b> | Roll the horizontal view .....  | 54 |
|                        | Zoom the horizontal view .....  | 54 |
|                        | View in XY mode .....   | 55 |
| <b>Vertical View</b>   | Select the coupling method .....                                      | 56 |
|                        | Invert the waveform .....   | 57 |
|                        | Limit the frequency bandwidth .....                                   | 58 |
|                        | Select the probe attenuation .....                                    | 58 |
| <b>Other Settings</b>  | Select the buzzer sound .....   | 59 |
|                        | View the Help information .....                                       | 59 |

|                                      |    |
|--------------------------------------|----|
| View the system information .....    | 60 |
| Select the language .....            | 60 |
| Set the Date .....                   | 61 |
| Set the Time .....                   | 62 |
| Battery Maintenance (Optional) ..... | 63 |

---



## Acquisition

Acquisition process samples the analog input signal and converts it into digital format, later to be reconstructed into waveform.

### Select the Acquisition mode

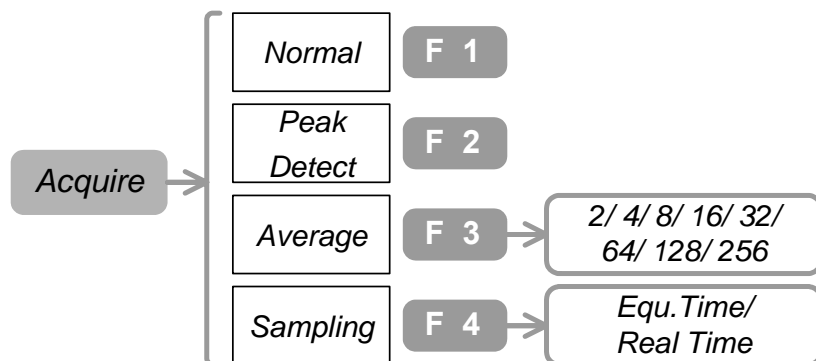

Panel operation



1. Press the Acquire key. Select the acquisition mode among F1~F3 and press it. The acquisition icon on the top right corner of the display changes accordingly.
2. (For Average mode) To select the number of samples, press F3 repeatedly.
3. To select the Sampling mode, press F4 repeatedly.

Range

#### Acquisition mode

|   |  |
|---|--|
| Normal       | All the acquisition information is used to draw the waveform.  |
| Peak Detect  | The minimum and maximum value pairs for each acquisition interval (bucket) are stored. Useful in catching abnormal glitches in the signal. |
| Average      | Multiple acquisitions are averaged to draw a noise-free waveform.  |
|   | <b>Average number</b><br>2, 4, 8, 16, 32, 64, 128, 256   |

#### Sampling mode

The first sample during each acquisition interval

is recorded.

Equ. Time

Equivalent Time sampling.

GDS-2000 draws the waveform by accumulating the sample records.

Use this only for repetitive signal.

Real Time

Real Time sampling. GDS-2000 draws the waveform from a single sample record.

**Example**

**Normal mode**

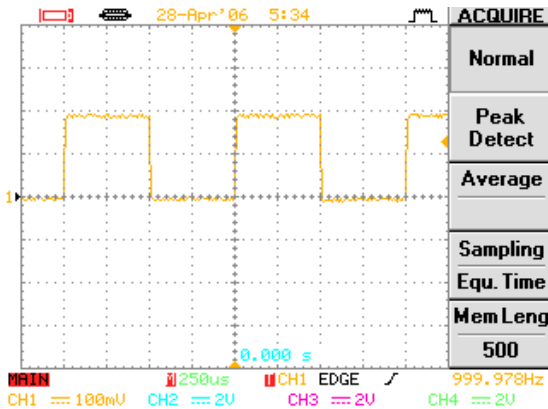

**Peak Detect mode**

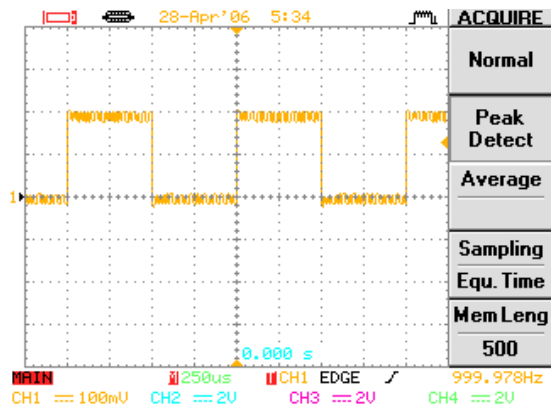

**Average mode**

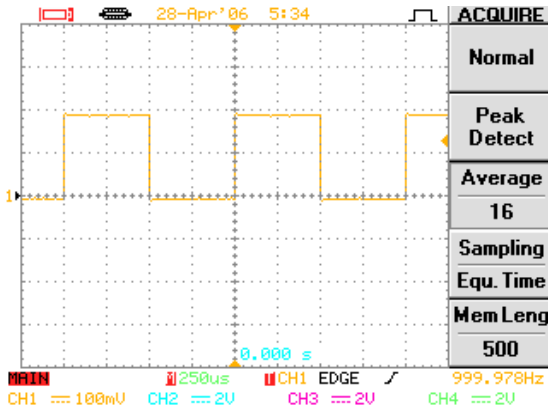

## Select the waveform memory length

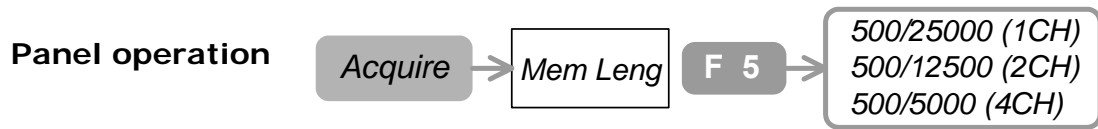

1. Press the Acquire key→F5.
2. To switch between short and long memory length, press F5 repeatedly.

| Range |  |  |
|-------|--|--|
| 500   |  | Short memory length: useful when catching high frequency signal. |
| 5000  |  | Long memory length when three or four channels are active        |
| 12500 |  | Long memory length when two channels are active                  |
| 25000 |  | Long memory length when only one channel is active               |



# Cursor

## Select the horizontal cursor type

### Panel operation

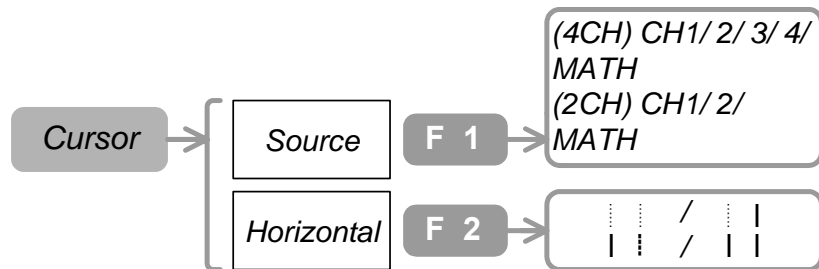

1. Press the Cursor key→F1. To select the signal, press F1 repeatedly.
2. To select the cursor to be activated, press F2 repeatedly.
3. To move the cursor, use the Variable knob .
4. The bottom right corner of the display shows the positions of two cursors (T1 & T2), their time difference ( $\Delta$ ), and the calculated frequency (f).

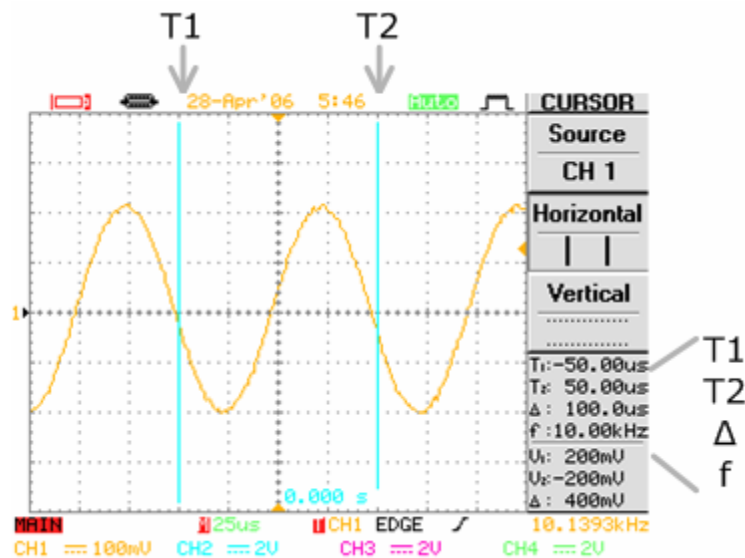

---

| Range | Source                          |  |
|-------|---------------------------------|--|
|       | CH1~CH4<br>(4CH model)          | Channel1~Channel2 waveform   |
|       | CH1~CH2<br>(2CH model)          | Channel1~Channel2 waveform   |
|       | MATH                            | The waveform resulted from the math operation                      |
|       | <b>Horizontal (cursor type)</b> |  |
|       | ∴ ∴                             | Both T1 and T2 are invisible.                                      |
|       | ∴                               | T2 is active, T1 is fixed. Variable knob moves only T2.            |
|       | ∴                               | T1 is active, T2 is fixed. Variable knob moves only T1.            |
|       |                                 | Both T1 and T2 are active. Variable knob moves T1 and T2 together. |

---

## Select the vertical cursor type

### Panel operation

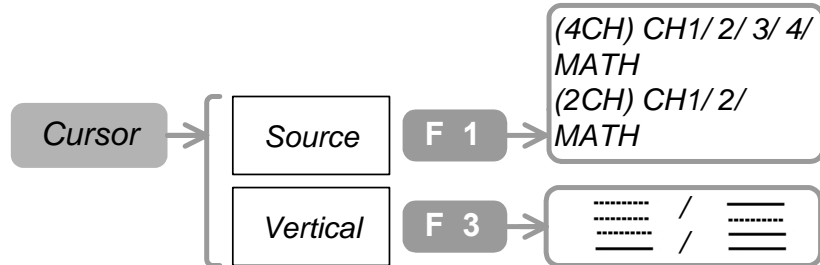

1. Press the Cursor key→F1. To select the signal, press F1 repeatedly.
2. To select the cursor to be activated, press F3 repeatedly.
3. To move the cursor, use the Variable knob .
4. The bottom right corner of the display shows the positions of two cursors (V1 & V2) and their voltage difference ( $\Delta$ ).

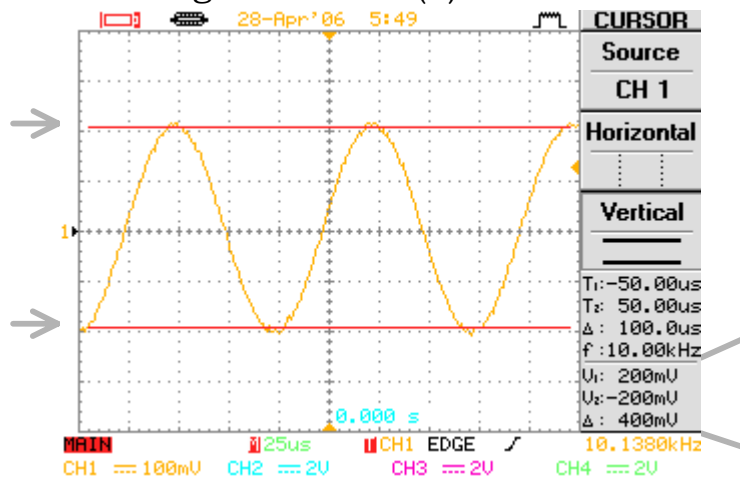

---

| Range | Source                        |  |
|-------|-------------------------------|--|
|       | CH1~CH4<br>(4CH model)        | Channel1~Channel4 waveform   |
|       | CH1~CH2<br>(2CH model)        | Channel1~Channel2 waveform   |
|       | MATH                          | The waveform resulted from the Math operation.                     |
|       | <b>Vertical (cursor type)</b> |  |
|       | ⋯⋯⋯                           | Both V1 and V2 are invisible.                                      |
|       | —                             | V2 is active, V1 is fixed. Variable knob moves only V2.            |
|       | ⋯⋯⋯                           | V1 is active, V2 is fixed. Variable knob moves only V1.            |
|       | ==                            | Both V1 and V2 are active. Variable knob moves V1 and V2 together. |

---



# Display

## Select the vector/dot waveform

Panel operation



1. Press the Display key→F1.
2. To select the line format, press F1 repeatedly.

|       |         |   |
|-------|---------|---|
| Range | Vectors | The sampled dots are connected to form a waveform line. |
|       | Dots    | Only the sampled dots are shown on the display          |

### Example

Vectors

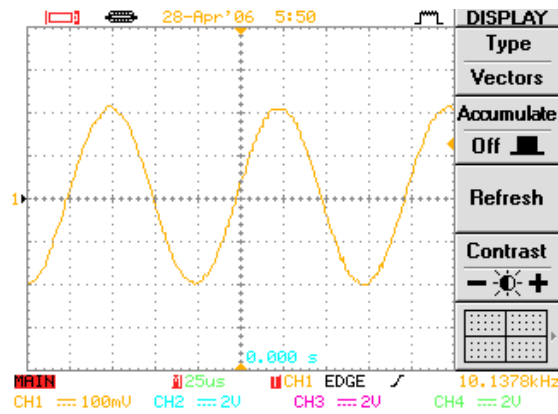

Dots

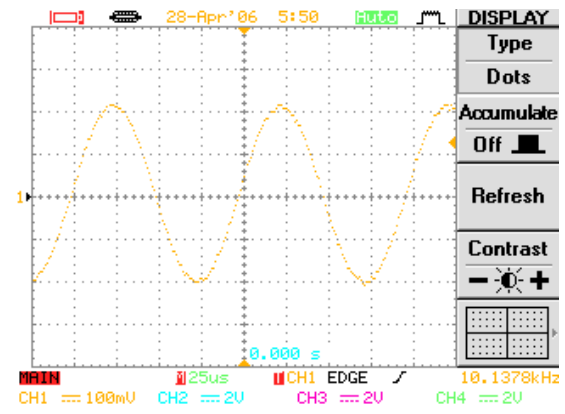

## View accumulated waveform

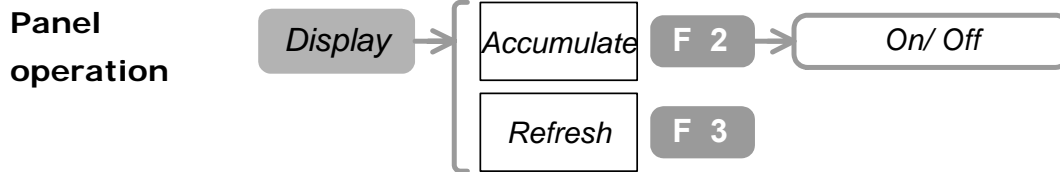

1. Press the Display key→F2.
2. To turn Off accumulation, press F2 again.
3. To reset the accumulated waveform, press F3.

|       |     |  |
|-------|-----|--|
| Range | On  | The waveform is accumulated in the display to show the variation |
|       | Off | The previous waveform is erased each time                        |

### Example

Accumulation Off

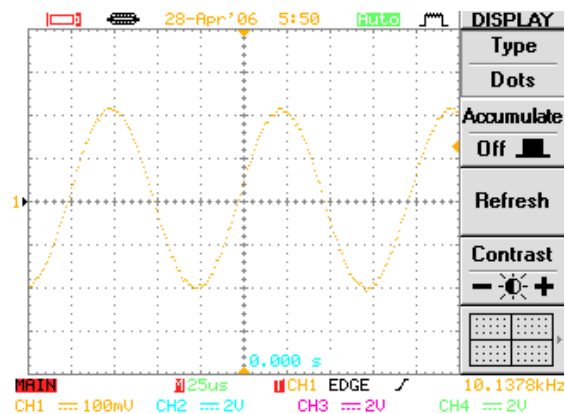

Accumulation On

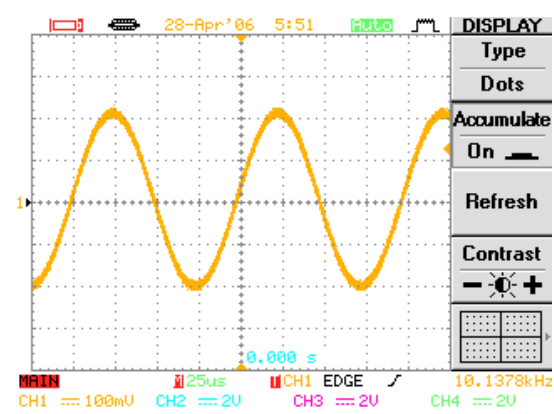

---

## Set the display contrast

---

Panel operation



1. Press the Display key→F4.
  2. To change the contrast, use variable knob .
- 

---

## Freeze the waveform

---

Panel operation

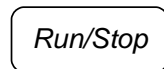

1. To freeze the waveform (and the trigger), press the Run/Stop button.
  2. To unfreeze the waveform, press the Run/Stop button again.
-

## Select the display grid type

Panel operation



1. Press the Display key→F5.
2. To select the grid type, press F5 repeatedly.

Range



Only displays X and Y axis



Displays full grid



Only displays outer frame

### Example

#### Full grid

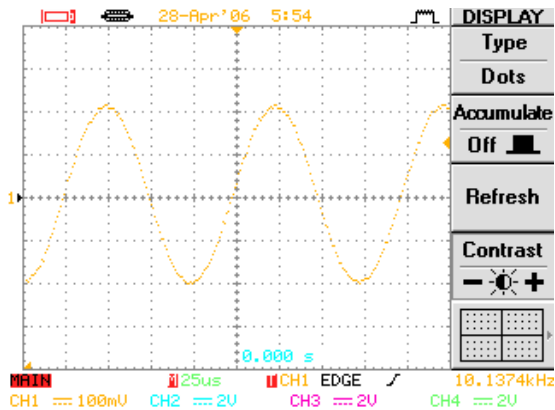

#### X and Y axis only

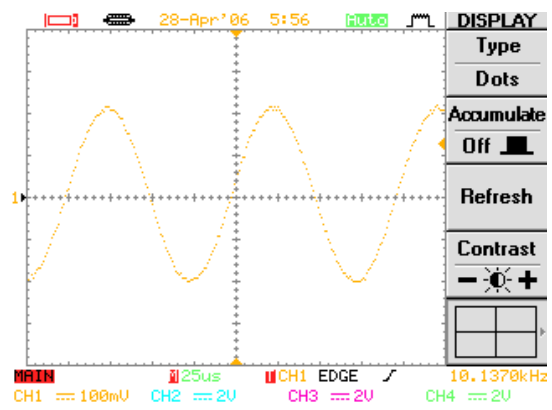

#### Outer frame only

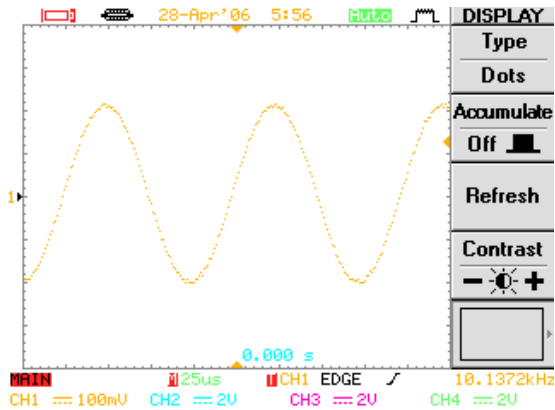

## Turn Off the display menu

Panel operation

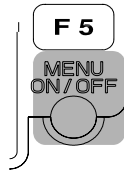

1. Press the MENU ON/OFF key.
2. To turn the menu On, press again.

### Example

Menu On

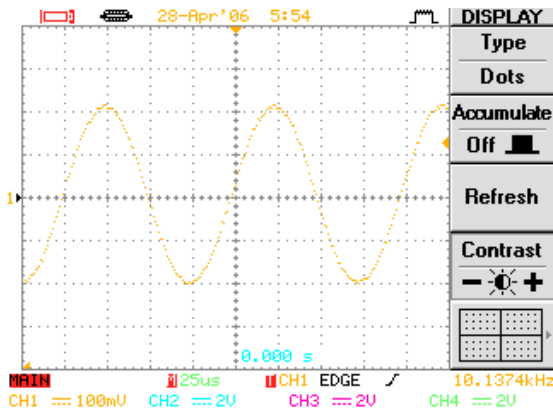

Menu Off

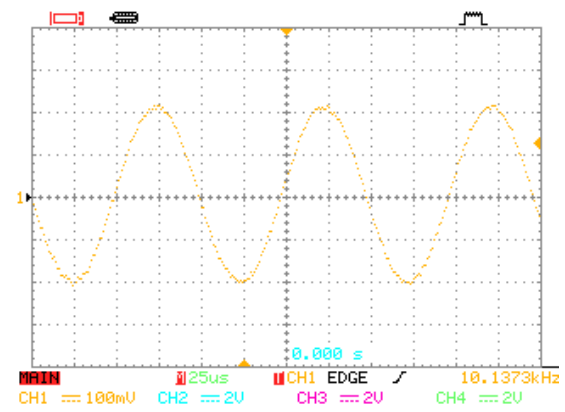

## Horizontal View



### Roll the horizontal view

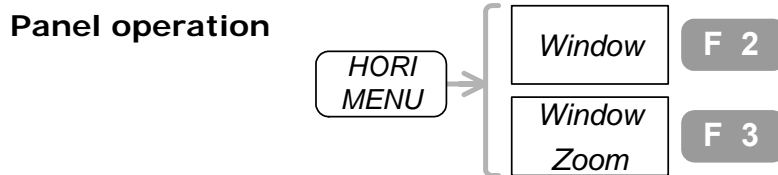

1. Press the Horizontal key→F4.
2. To go back to the default (main) view, press F1.

### Zoom the horizontal view



1. Press the Horizontal key→F2.
2. To set the zoom range, use Time/Div knob .
3. To set the zoom range position, use Horizontal Position knob .
4. To zoom in, press F3.
5. The memory bar on the top of the display shows the zoomed portion of the entire waveform.

Range            1ns~1ms





## View in XY mode

**Not** available for Channel 3 and Channel 4

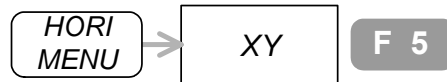
---

Panel operation



1. Feed Channel1 (horizontal) and Channel2 (vertical) signal.
  2. Press the Horizontal key→F5.
  3. To set the horizontal scale and position, use Channel1 Volts/Div knob  and Position knob .
  4. To set the vertical scale and position, use Channel2 Volts/Div knob  and Position knob .
-

# Vertical

## Select the coupling method

Panel operation



1. Press the Channel key→F1.
2. To select the coupling, press F1 repeatedly.

Range



AC coupling



DC coupling



Ground coupling

Example

Observe the AC portion of a signal using AC coupling

DC Coupling

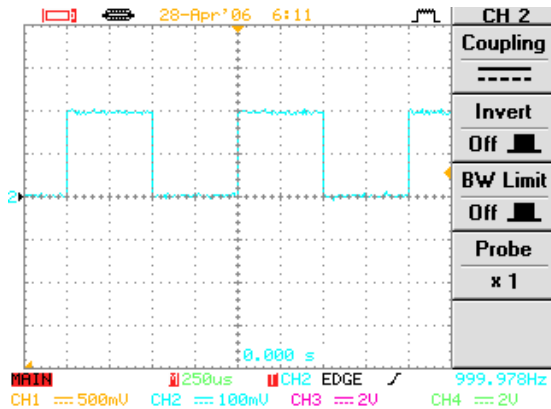

AC Coupling

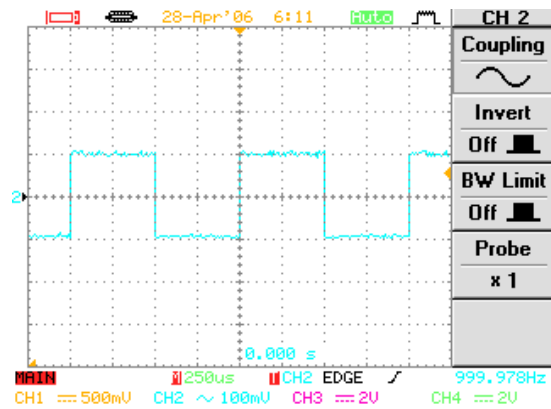



## Invert the waveform

Panel operation



1. Press the Channel key→F2.
2. To cancel the effect, press F2 again.

### Example

CH2 (lower waveform) Invert Off

CH2 Invert On

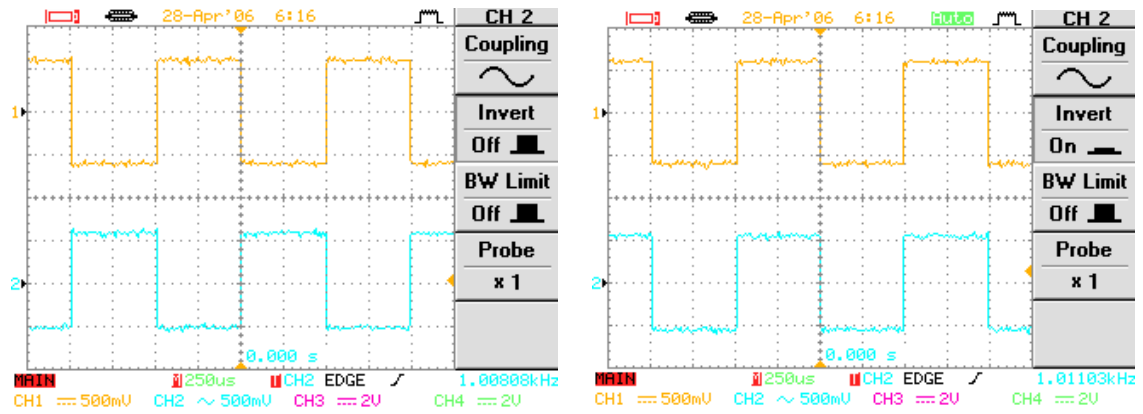

The trigger is also inverted.

## Limit the frequency bandwidth

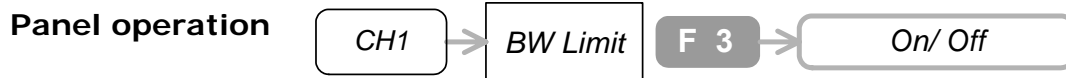

1. Press the Channel key→F3.
2. To cancel the effect, press F3 again.

|       |              |                             |
|-------|--------------|-----------------------------|
| Range | BW Limit On  | Frequency bandwidth: 20MHz  |
|       | BW Limit Off | Frequency bandwidth: 100MHz |

## Select the probe attenuation

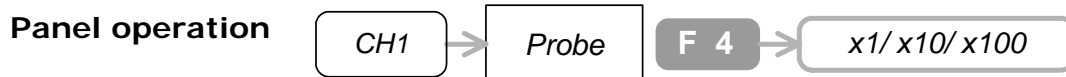

1. Press the Channel key→F4.
2. To select the attenuation level, press F4 repeatedly.
3. Vertical scale is adjusted accordingly.

|       |      |                        |
|-------|------|------------------------|
| Range | x1   | No attenuation         |
|       | x10  | Attenuation factor 10  |
|       | x100 | Attenuation factor 100 |

## Other Settings



### Select the buzzer sound

Panel operation



1. Press the Utility key→F3.
2. To select the buzzer setting, press F3 repeatedly.

Range

|   |             |
|---|-------------|
|  | Low pitch   |
|  | High pitch  |
|  | Mixed pitch |
| Off   | No sound    |

### View the Help information

GDS-2000 has built-in help accessible from the front panel.

Panel operation

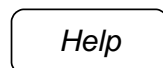

1. Press the Help key. The waveform freezes and the front panel switches to “Help” mode.
2. To view the built-in help, select a key from the following and press it. The key functionality will be shown on the display.  
**Acquire, Cursor, Display, Measure, Program, Utility**
3. To go back to normal operation, press the Help key again.

## View the system information

Panel operation



1. Press the Utility key→F5→F2.
2. The following information is shown.  
Model name, Serial No, Firmware version, battery voltage and capacity (optional).

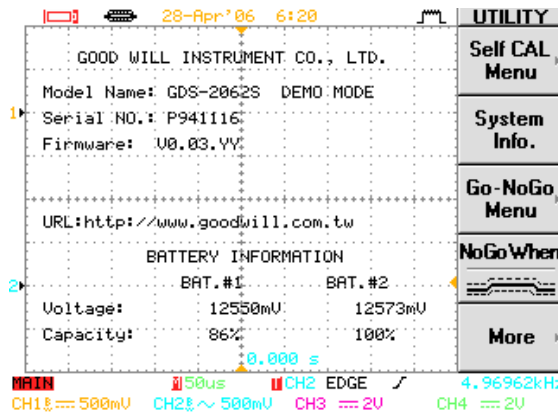

3. To go back to the signal view, press the other key.

## Select the language

Panel operation

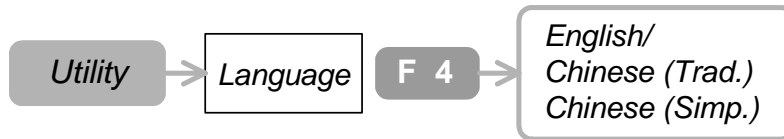

Press the Utility key→F4. To select the language, press F4 repeatedly.

Range

- English
- Chinese Traditional
- Chinese Simplified

## Set the Date

### Panel operation

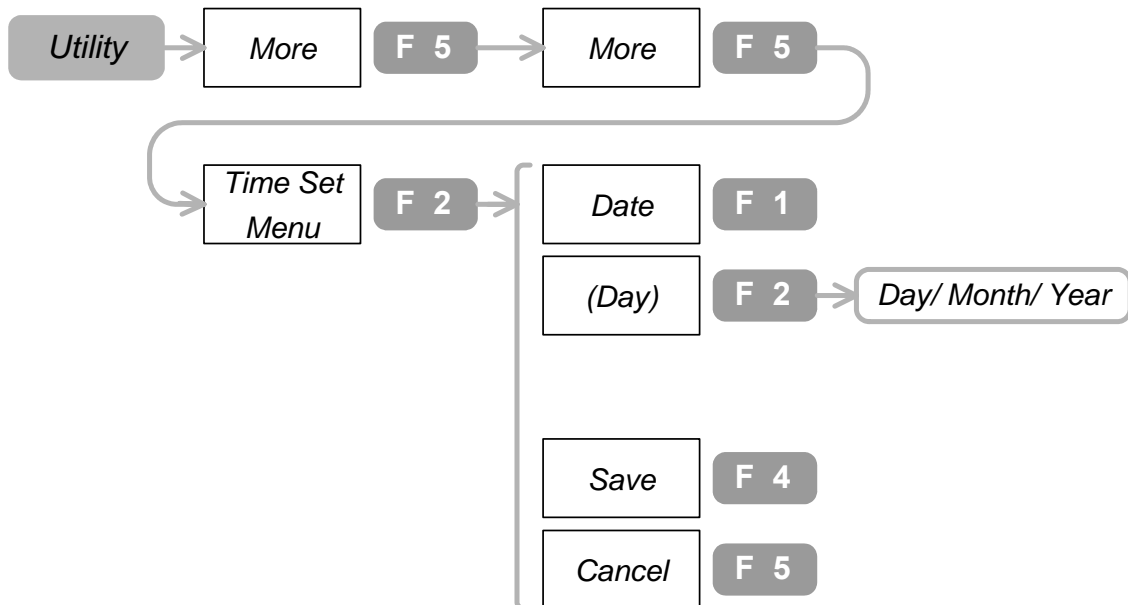



1. Press the Utility key→F5→F5→F2. Press F1 again if “Date” does not appear.
2. To select the date item, press F2 repeatedly.
3. To set the parameter, use the Variable knob .
4. To save the change, press F4 twice.
5. To go back to the previous menu, press F5.

|       |       |           |
|-------|-------|-----------|
| Range | Day   | 1~31      |
|       | Month | 1~12      |
|       | Year  | 2000~2037 |

## Set the Time

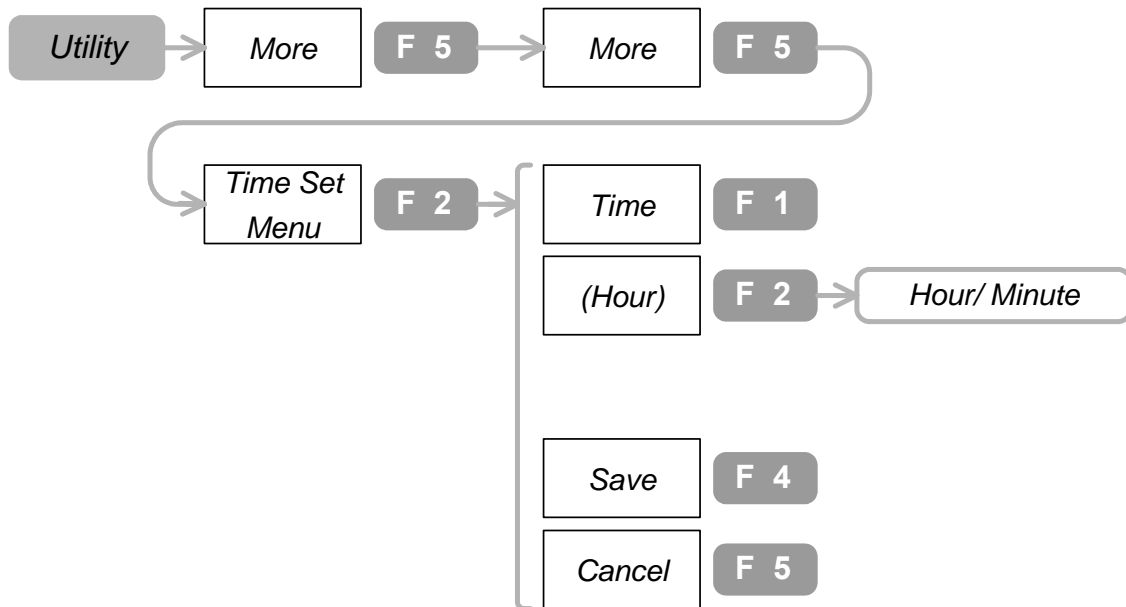
### Panel operation



1. Press the Utility key→F5→F5→F2→F1. Press F1 again if “Time” does not appear.
2. To select the time item, press F2.
3. To set the parameter, use the Variable knob .
4. To save the change, press F4 twice.
5. To go back to the previous menu, press F5.

|       |        |      |
|-------|--------|------|
| Range | Hour   | 0~23 |
|       | Minute | 0~59 |

## Battery Maintenance (Optional)

The battery is a factory-installed optional item. Contact your local dealer for purchase and installation.

**Specification** Li-Ion, 10.8V 1600mAh per pack (two packs for one GDS-2000 unit)  
 Charging time: Twelve hours approx.  
 Operation time: Three hours approx.

**Battery information** To view battery status, press Utility key→F5→F2.

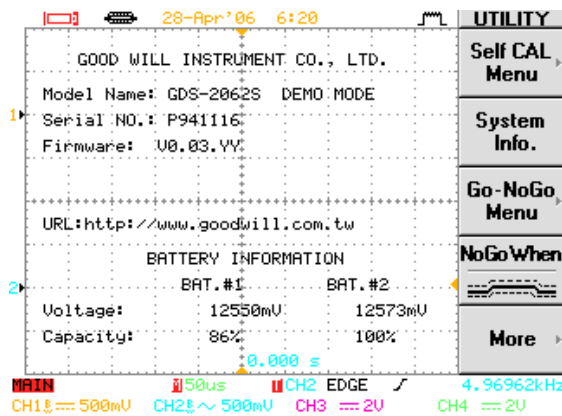

Battery voltage and charge information is shown on the lower pane.

**When not in use** Take the batteries out of the unit to prolong the battery life.

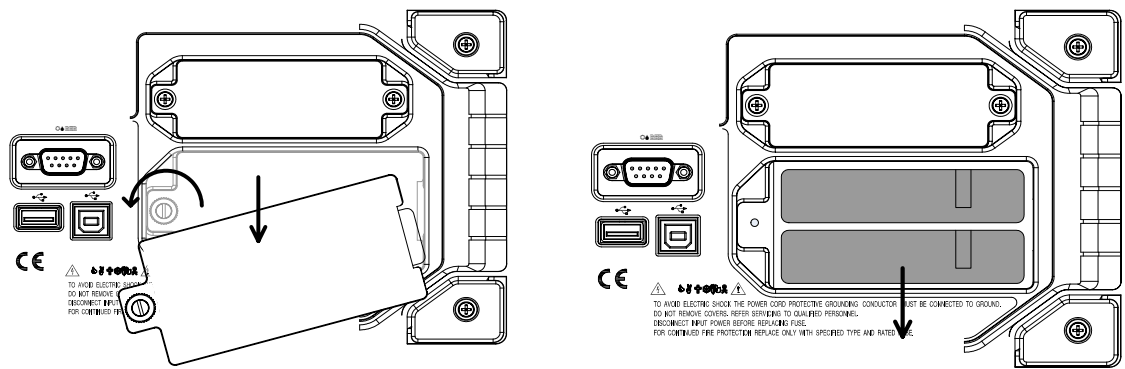

---

# Measurements

---

|                               |   |    |
|-------------------------------|---|----|
| <b>Automatic Measurements</b> | Auto Set.....                                 | 65 |
|                               | Run automatic measurements .....              | 66 |
|                               | View automatic measurement results .....      | 69 |
| <b>Go-No Go Test</b>          | Edit Go-No Go test condition .....            | 70 |
|                               | Run Go-No Go test.....                        | 73 |
| <b>Math Operation</b>         | Add/ Subtract/ Multiply/ Divide signals ..... | 74 |
|                               | Run FFT operation .....                       | 75 |
| <b>Program and Play</b>       | Edit the program steps .....                  | 76 |
|                               | Play the program.....                         | 77 |
| <b>Trigger</b>                | Use Edge trigger.....                         | 78 |
|                               | Use Video trigger.....                        | 80 |
|                               | Use Pulse width trigger.....                  | 81 |
|                               | Use Advanced delay trigger.....               | 83 |

---



## Automatic Measurements

### Auto Set

Auto Set automatically finds the appropriate settings (vertical, horizontal, trigger) for the input signals.

Limitation: Signals under 30mV or 30Hz would not be configured.

#### Panel Operation

*Auto Set*

The following is the Auto Set configuration.







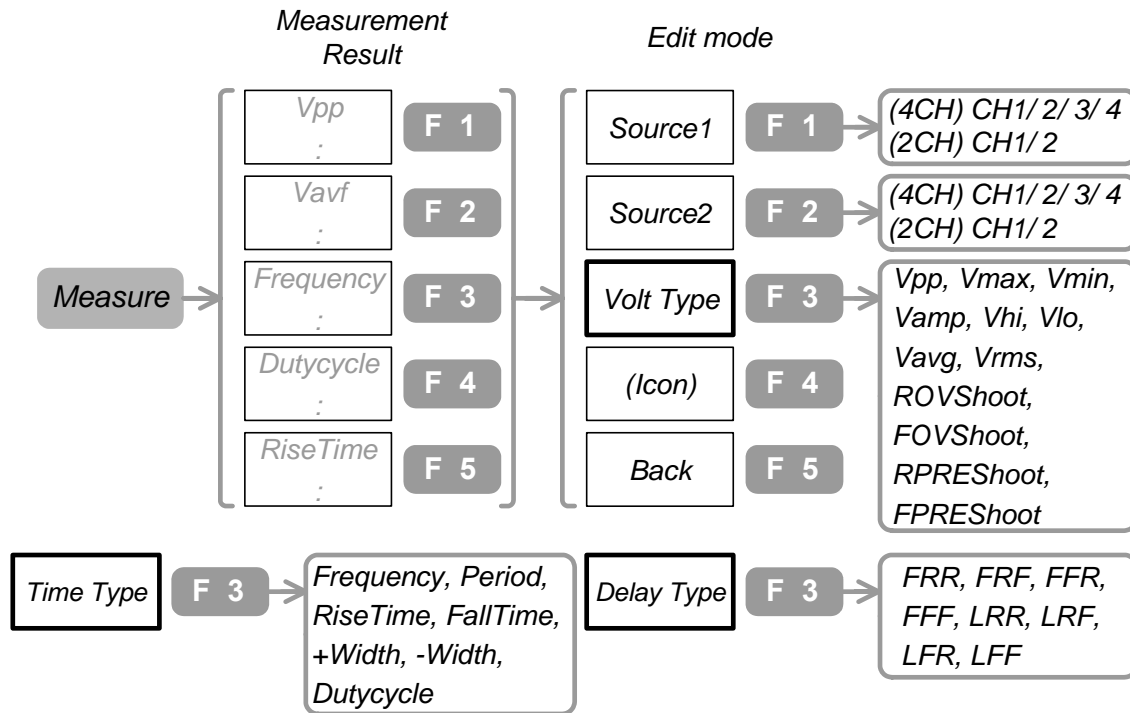



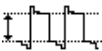

|                    |  |  |
|--------------------|--|--|
| <b>Acquisition</b> | Mode:<br>Stop after:   | Sample<br>RUN/STOP button only   |
| <b>Display</b>     | Style:<br>Format:  | Vectors<br>YT  |
| <b>Horizontal</b>  | Scale:<br>Position:  | Signal frequency dependent<br>Centered within the graticule window                               |
| <b>Trigger</b>     | Coupling:<br>Position:<br>Slope:<br>Type:<br>Source:<br>Level: | DC<br>Center<br>Positive<br>Edge<br>Highest frequency<br>Midpoint of data for the trigger source |
| <b>Vertical</b>    | Bandwidth:<br>Offset:<br>Coupling:<br>Scale:                   | Full<br>0<br>Signal dependent<br>Signal dependent  |

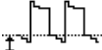
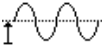

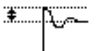
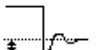

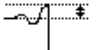
## Run automatic measurements

### Panel operation











1. Press the Measure key. F1 to F5 shows the result from the previous measurement.
2. Press any of F1~F5. The menu switches to edit mode.
3. To select the first measuring object channel, press F1 repeatedly.
4. To select the second measuring object channel, press F2 repeatedly.
5. To select the measurement type, press F3 repeatedly.
6. To select the measurement parameter, use the Variable knob . The corresponding icon is shown on F4.
7. To go back to the measurement result view, press F5.

|              |   |   |
|--------------|---|---|
| <b>Range</b> | <b>Source 1, 2</b>  |   |
|              | (4CH) CH1~CH4   | (4CH model) Channel1~Channel2   |
|              | (2CH) CH1,CH2   | (2CH model) Channel1,Channel2   |
|              | <b>Volt type</b>  |   |
| Vpp          |    | Difference between positive and negative peak voltage.<br>(=Vmax-Vmin)  |
| Vmax         |    | Positive peak voltage.  |
| Vmin         |    | Negative peak voltage.  |
| Vamp         |    | Difference between global high and global low voltage.<br>(=Vhi - Vlo). |
| Vhi          |  | Global high voltage.  |
| Vlo          |  | Global low voltage.   |
| Vavg         |  | Averaged voltage of the first cycle.                                    |
| Vrms         |  | Root Mean Square voltage.   |
| ROVShoot     |  | Rise Overshoot voltage.   |
| FOVShoot     |  | Fall Overshoot voltage.   |
| RPREShoot    |  | Rise Preshoot voltage.  |
| FPREShoot    |  | Fall Preshoot voltage.  |
|              | <b>Time Type</b>  |   |
| Freq         |  | Frequency of the waveform.  |
| Period       |  | Waveform cycle time. (=1/Freq)  |
| Risetime     |  | Rising time of the pulse (~90%)   |

|            |   |   |
|------------|---|---|
| Falltime   |  | Falling time of the pulse (90%~)  |
| +Width     |  | Positive pulse width.   |
| -Width     |  | Negative pulse width.   |
| Duty Cycle |  | The ratio of the signal pulse compared with the whole cycle.<br>(=100x Pulse Width/Cycle) |

**Delay Type**

|     |   |   |
|-----|---|---|
| FRR |    | Time between Source1 signal <b>first rising</b> edge and Source2 signal <b>first rising</b> edge.   |
| FRF |    | Time between Source1 signal <b>first rising</b> edge and Source2 signal <b>first falling</b> edge.  |
| FFR |  | Time between Source1 signal <b>first falling</b> edge and Source2 signal <b>first rising</b> edge.  |
| FFF |  | Time between Source1 signal <b>first falling</b> edge and Source2 signal <b>first falling</b> edge. |
| LRR |  | Time between Source1 signal <b>first rising</b> edge and Source2 signal <b>last rising</b> edge.    |
| LRF |  | Time between Source1 signal <b>first rising</b> edge and Source2 signal <b>last falling</b> edge.   |
| LFR |  | Time between Source1 signal <b>first falling</b> edge and Source2 signal <b>last rising</b> edge.   |
| LFF |  | Time between Source1 signal <b>first falling</b> edge and Source2 signal <b>last falling</b> edge.  |

## View automatic measurement results

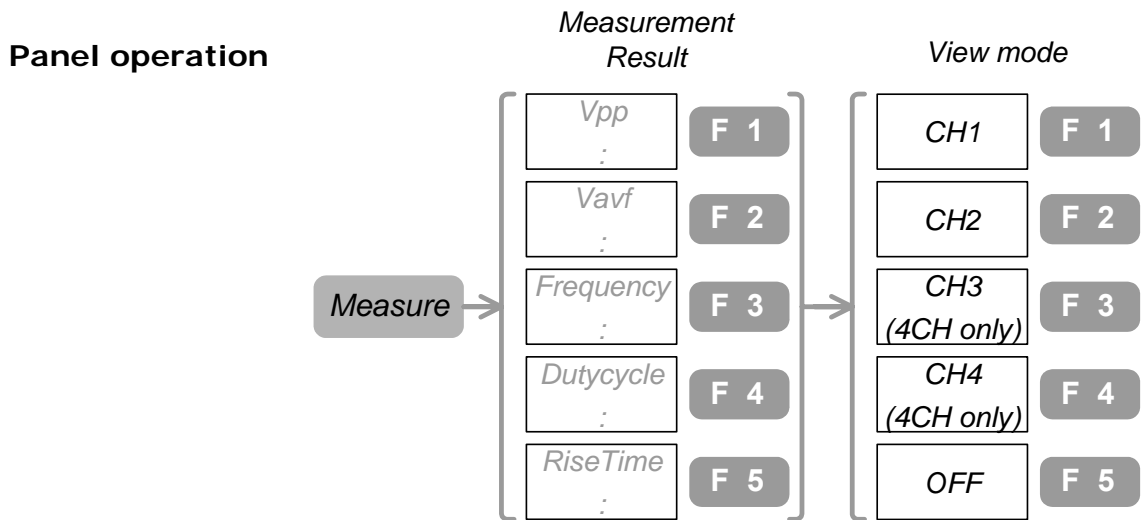

1. Two viewing modes are available: selected results on the menu pane (press Measure key once) and full list of results on the display (press Measure key again).
2. To view the full result, press the Measure key repeatedly until the view mode appears.
3. To view the measurement results, select the channel from F1~F4 and press it. GDS-2000 runs all the applicable Voltage and Time type measurements, shows the result on the display.

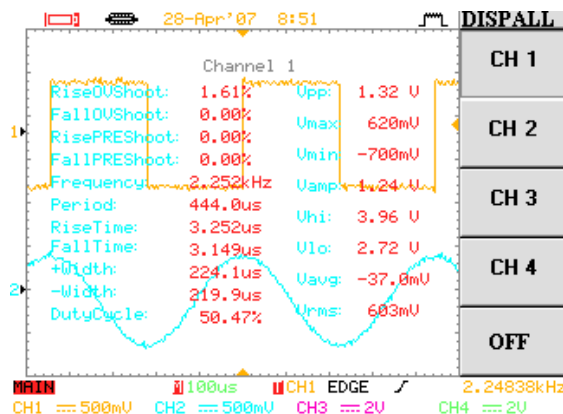



4. To bring back the signal view again, press F5.

# Go-No Go Test

## Edit Go-No Go test condition

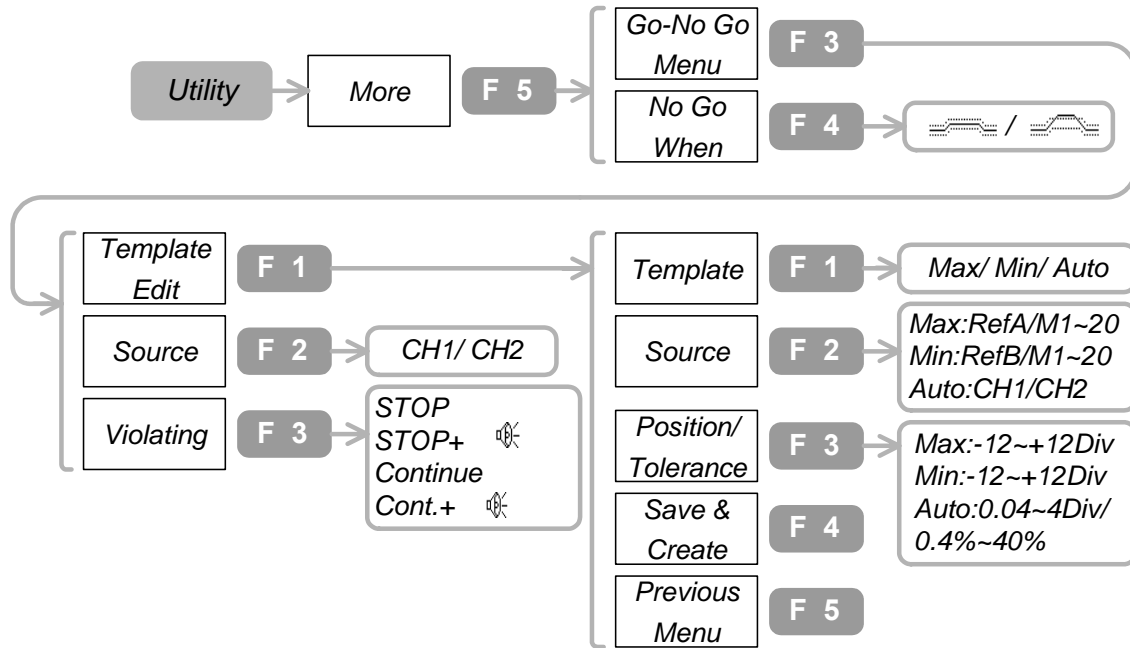
### Panel operation



1. Press the Utility key→F5. To select No Go When (violation condition), press F4 repeatedly.
2. Press F3 and go into Go-No Go menu.
3. To select the test subject signal, press F2 repeatedly.
4. To select the violation event, press F3 repeatedly.
5. Press F1 and go into template edit menu.
6. To select the template, press F1 repeatedly.
7. To select the template source, press F2 repeatedly.
8. To select the template position (Maximum/Minimum) or tolerance (Auto), use Variable knob .
9. To save the edited template, press F4.

10. To go back to the previous menu, press F5.

Range

**Go-No Go When (violation condition)**

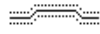

No Go means the subject signal is within the template.

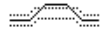

No Go means the subject signal is violating the template.

**Template**

Max

Sets the maximum side of the template.

**Template source**

RefA: Reference waveform that has to be stored in advance.

M1~20: Templates stored in advance in internal memory.

To store a waveform (template) internally, see page **Error! Bookmark not defined.**

**Template position**

±12/Div

Min

Sets the minimum side of the template.

**Template source**

RefB: Reference waveform that has to be stored in advance.

M1~20: Templates stored in advance in internal memory.

To store a waveform (template) internally, see page **Error! Bookmark not defined.**

**Template position**

±12/Div

Auto Automatically creates the maximum and minimum template from an incoming signal, specifying the margin (tolerance) around the waveform.

**Template source**

CH1: Use Channel1 signal

CH2: Use Channel2 signal

**Template tolerance**

0.4%~40%

Creating a template in Auto mode

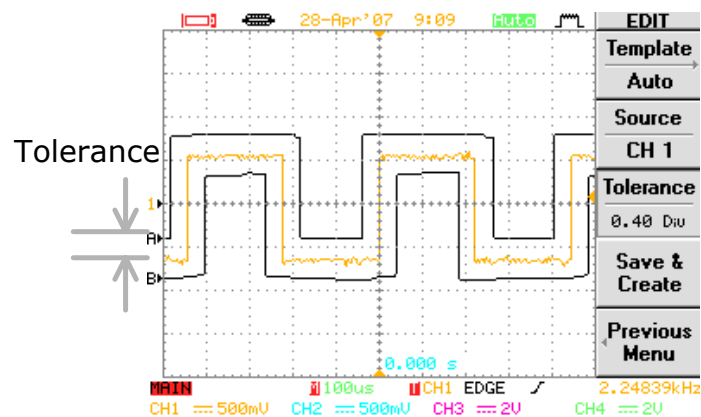

**Source signal**

CH1 Channel1 as the subject of test

CH2 Channel2 as the subject of test

**Violation Condition**

Stop The test stops in case of violation.

Stop+  The test stops with a buzzer sound in case of violation.

Continue The test continues even in case of violation.

Cont.+  The test continues but with a buzzer sound in case of violation.



## Run Go-No Go test

### Panel operation

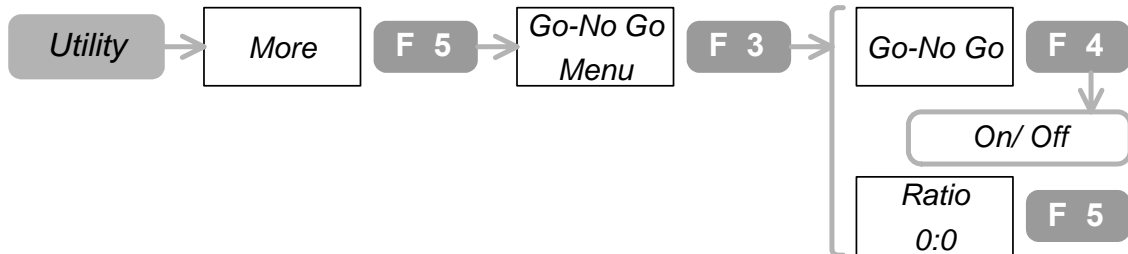

1. Edit the test condition. See page70.
2. Press the Utility key→F5→F3.
3. To run Go-No Go test, press F4.
4. To stop Go-No Go test, press F4 again.
5. The test result is shown on F5 as (Number of test: Number of violation).
6. GDS-2000 can output the test result as a 10us pulse signal from the rear panel.



Rear panel output terminal (Open Collector)

# Math Operation

## Add/ Subtract/ Multiply/ Divide signals

Panel operation

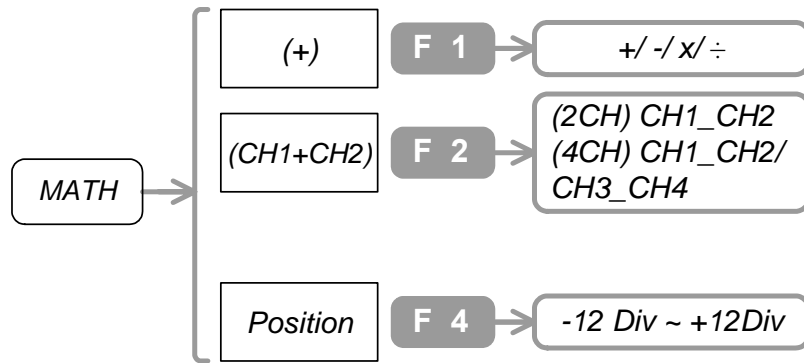

1. Press the Math key.
2. To select the operation type, press F1 repeatedly.
3. (only for 4CH model) To select the channel pairs, press F2 repeatedly.
4. To set the position of the resulted waveform, press F4. Then use the Variable knob .

Range

### Math Operation type

|   |                |
|---|----------------|
| + | Addition       |
| - | Subtraction    |
| × | Multiplication |
| ÷ | Division       |

### Channel Pair

|         |  |
|---------|--|
| CH1_CH2 | Math operation between Channel1 and Channel2                         |
| CH3_CH4 | Math operation between Channel3 and Channel4<br>(only for 4CH model) |

### Position

-12Div~+12Div

## Run FFT operation

Not available for Channel3 and Channel4

### Panel operation

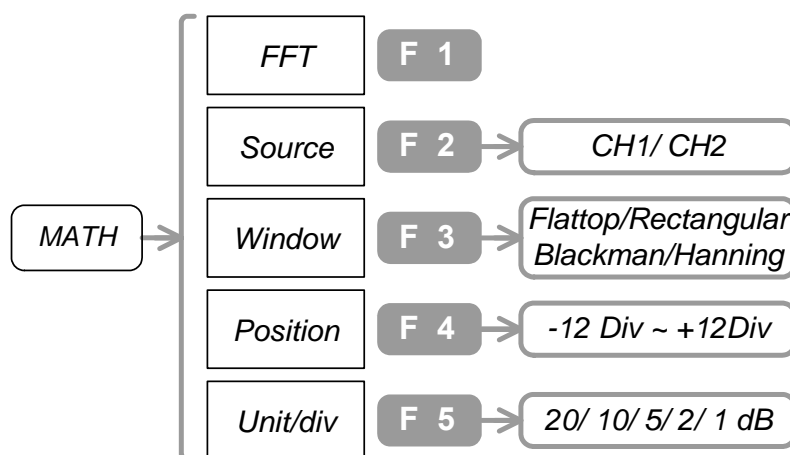

1. Press the Math key→F1. Press F1 repeatedly until “FFT” comes up.
2. To select the subject channel, press F2 repeatedly.
3. To select the FFT window type, press F3 repeatedly.
4. To set the position of the resulted waveform, press F4. Then use the Variable knob .
5. To select the amplitude scale, press F5 repeatedly.

### Range

#### FFT Window

|             |   |
|-------------|---|
| Rectangular | Suitable for transient analysis.  |
| Blackman    | Frequency resolution is not as good as Hanning, but comes with better sidelobe rejection. |
| Hanning     | Higher frequency resolution.  |
| Flattop     | Higher magnitude accuracy.  |

#### Position

-12Div~+12Div

#### Amplitude scale



1, 2, 5, 10, 20 dB/Div

## Program and Play

### Edit the program steps

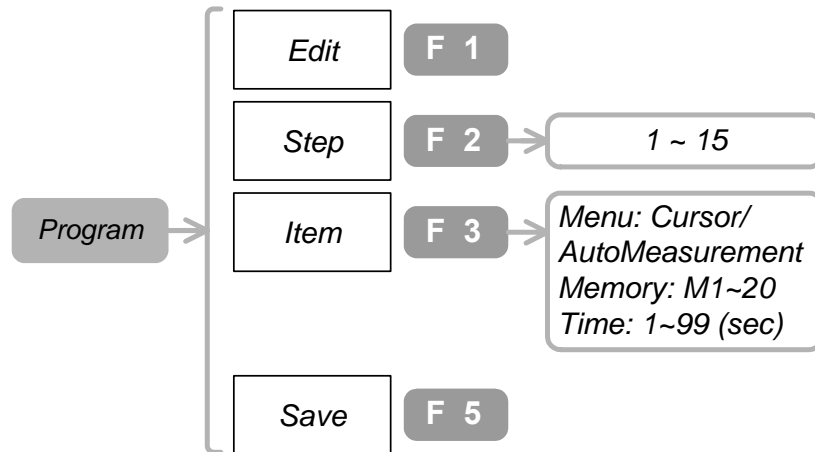
Panel operation



1. Press the Program key→F1. In case “Edit” menu does not appear, press F1 again.
2. To select the step to be edited, press F2. Then use Variable knob . The cursor in the display also moves accordingly.
3. To select the program item, press F3. Then use Variable knob  and select the parameter.
4. To save the edited step, press F5.
5. Repeat the above for the other steps.

|              |                      |   |
|--------------|----------------------|---|
| <b>Range</b> | <b>Step (number)</b> |   |
|              |                      | 1~20  |
|              | <b>Item</b>          |   |
|              | Menu                 | “AutoMeasure” or “Cursor”.                                      |
|              | Memory               | M1~M20 predefined waveforms.<br>To store waveforms, see pagexx. |
|              | Time                 | 1~99 seconds for each step.                                     |

## Play the program

### Panel operation

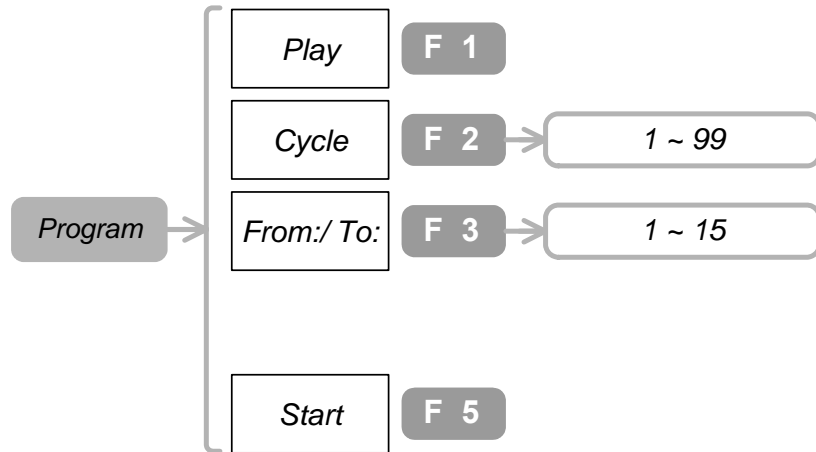

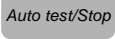
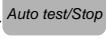
1. Edit the program. See page76.
2. Press Program key→F1. In case “Play” menu does not appear, press F1 again.
3. To set the number of repetition (cycle), press F2.Then use the Variable knob○.
4. To select “From:” step (beginning of the program), press F3. In case “From:” menu does not appear, press F3 again. Then use the Variable knob○.
5. To select “To:” step (end of the program), press F3. In case “To:” menu does not appear, press F3 again. Then use the Variable knob○.
6. To start the program, press F5 or press Auto test/Stop key  .
7. To stop the program, press Auto test/Stop key  again.

|              |  |
|--------------|--|
| <b>Range</b> | <b>Cycle (number of repetition)</b><br>1~99  |
|              | <b>From: / To: (beginning and end step)</b><br>1~15                      From: ≤ To: |

# Trigger



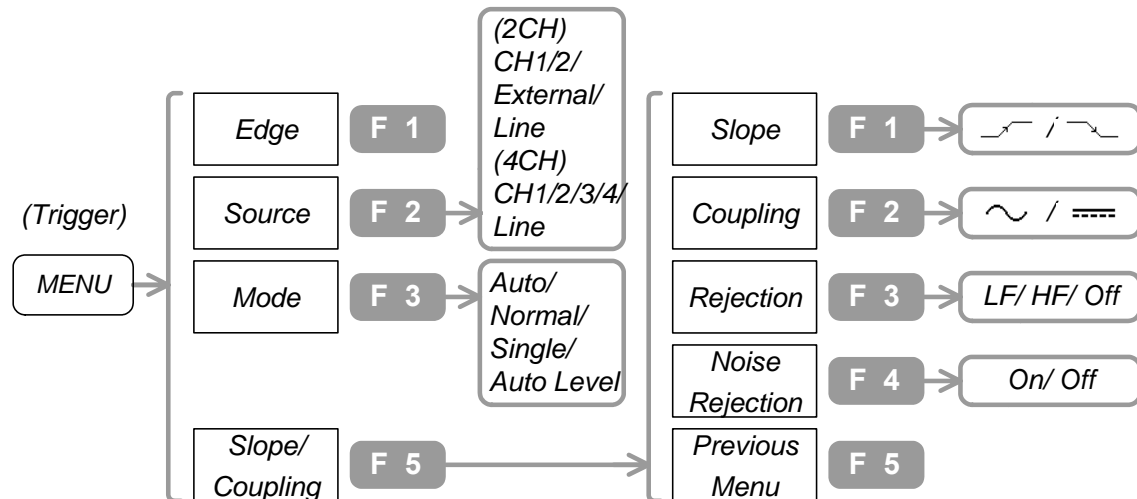

## Use Edge trigger

### Panel operation



1. Press the Trigger menu key. Press F1 repeatedly until “Edge” appears.
2. To select the trigger source signal, press F2 repeatedly.
3. To select the trigger mode, press F3 repeatedly.
4. To select the slope and coupling method, press F5.
5. To select the trigger slope, press F1 repeatedly.
6. To select the trigger coupling, press F2 repeatedly.
7. To select the frequency rejection mode, press F3 repeatedly.
8. To turn On noise rejection, press F4. To turn Off, press again.
9. To go back to the previous menu, press F5.

---

|              |   |   |
|--------------|---|---|
| <b>Range</b> | <b>Trigger source</b>   |   |
|              | CH1~CH2   | Channel1~Channel2 (2CH model)   |
|              | CH1~CH4   | Channel1~Channel4 (4CH model)   |
|              | External  | Signal from the External trigger input (only for 2CH model)   |
|              | Line  | AC Power supply signal  |
|              | <b>Trigger mode</b>   |   |
|              | Auto  | GDS-2000 generate an internal trigger if there is no trigger event. Select this mode when viewing rolling waveform at slower timebase, maximum 10s/div. |
|              | Normal  | GDS-2000 acquire waveform in a trigger event.   |
|              | Single  | GDS-2000 acquire waveform only once in a trigger event. Press Run/Stop key to acquire again.  |
|              | Auto Level  | GDS-2000 automatically adjust the trigger level indicator to the center part of the waveform.   |
|              | <b>Slope</b>  |   |
|              |  | Rising edge   |
|              |  | Falling edge  |
|              | <b>Coupling</b>   |   |
|              |  | AC coupling   |
|              |  | DC coupling   |
|              | <b>(Frequency) Rejection</b>  |   |
|              | LF  | Low Frequency rejection. Rejects frequency below 50kHz.   |
|              | HF  | High Frequency rejection. Rejects frequency above 50kHz.  |
|              | Off   | Rejection disabled  |
|              | <b>Noise Rejection</b>  |   |
|              | ON  | Uses DC coupling with low sensitivity to reject noise.  |
|              | OFF   | Noise rejection disabled  |

---

## Use Video trigger

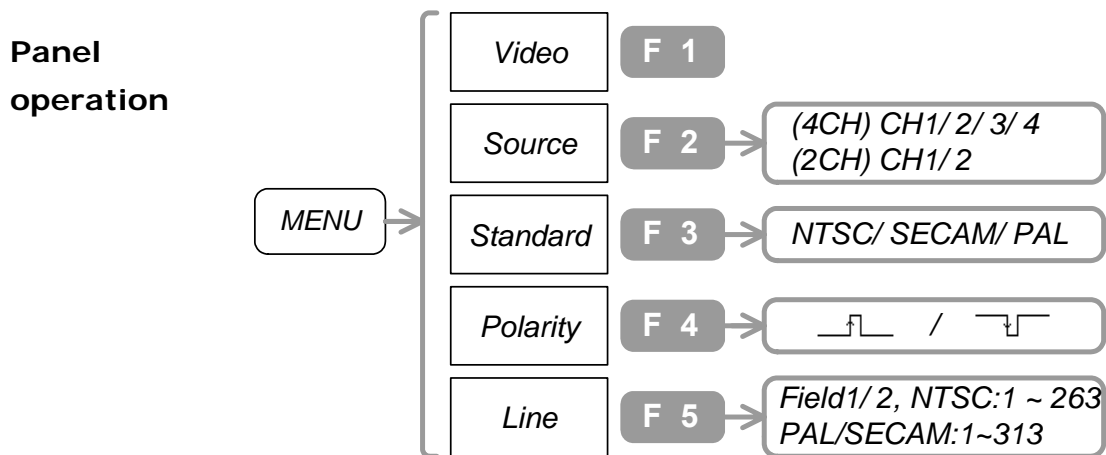

1. Press the Trigger menu key. Press F1 repeatedly until “Video” appears.
2. To select the trigger source signal, press F2 repeatedly.
3. To select the video standard, press F3 repeatedly.
4. To select the trigger polarity, press F4 repeatedly.
5. To select the trigger field line, press F5. Then use the Variable knob .

### Range

#### Trigger source

CH1~2(4) Channel1~Channel2 (Channel4)

#### Video standard

NTSC National Television System Committee video standard.

PAL Phase Alternative by Line video standard.

SECAM SEquential Couleur A Memoire video standard.

#### Polarity

Positive pulse

Negative pulse

#### Video Field

1 ~ 263 For NTSC



1 ~ 313 For PAL/ SECAM

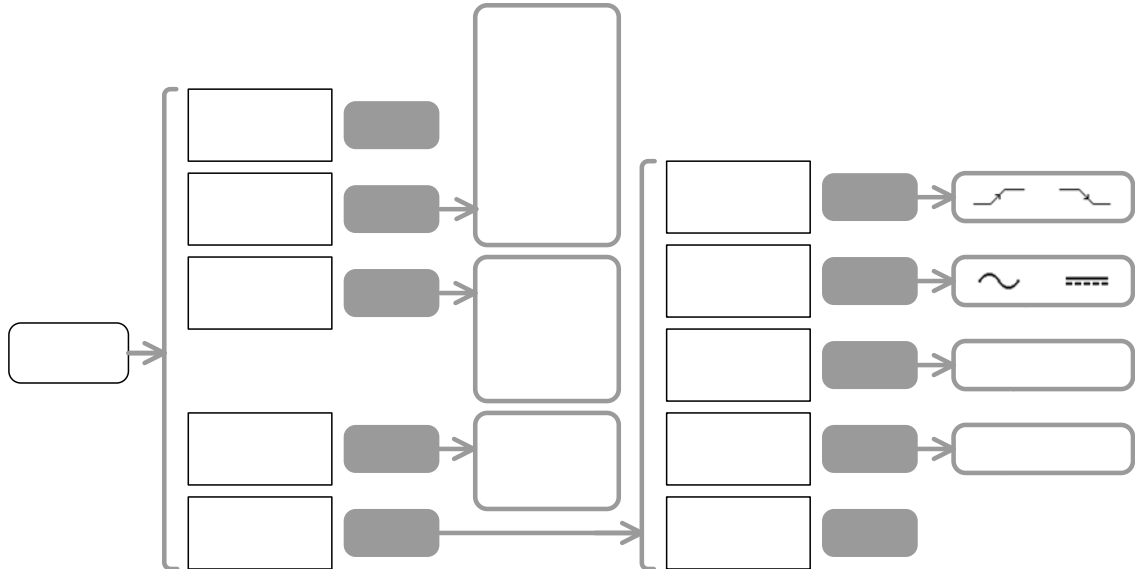

## Use Pulse width trigger

### Panel operation



1. Press the Trigger menu key. Press F1 repeatedly until “Pulse” appears.
2. To select the trigger source signal, press F2 repeatedly.
3. To select the trigger mode, press F3 repeatedly.
4. To select the trigger condition, press F4 repeatedly. To set the parameter, use the Variable knob .
5. To select the slope and coupling method, press F5.
6. To select the trigger slope, press F1 repeatedly.
7. To select the trigger coupling, press F2 repeatedly.
8. To select the frequency rejection mode, press F3 repeatedly.
9. To turn On noise rejection, press F4. To turn Off, press again.
10. To go back to the previous menu, press F5.
11. To set the trigger level, use the Trigger knob .

**Range**

**Trigger source**

CH1~CH4 Channel1~Channel4

|          |  |
|----------|--|
| External | External trigger input signal (only for 2CH model) |
| Line     | AC power input                                     |



**Trigger mode**

|            |  |
|------------|--|
| Auto       | GDS-2000 generates an internal trigger if there is no trigger event.                           |
| Normal     | GDS-2000 acquires waveform in a trigger event.   |
| Single     | GDS-2000 acquire waveform only once in a trigger event. Press Run/Stop key to acquire again.   |
| Auto Level | GDS-2000 automatically adjusts the trigger level indicator to the center part of the waveform. |

**Time compare factor**

|   |  |
|---|--|
| < | Trigger on pulse width smaller than the time setting   |
| > | Trigger on pulse width larger than the time setting    |
| = | Trigger on pulse width equal to the time setting       |
| ≠ | Trigger on pulse width different than the time setting |

**Slope**

|   |                                     |
|---|-------------------------------------|
|  | Trigger on the positive pulse width |
|  | Trigger on the negative pulse width |

**Coupling**

|   |             |
|---|-------------|
|  | AC coupling |
|  | DC coupling |

**(Frequency) Rejection**

|     |  |
|-----|--|
| LF  | Low Frequency rejection. Rejects frequency below 50kHz.  |
| HF  | High Frequency rejection. Rejects frequency above 50kHz. |
| Off | Rejection disabled                                       |

**Noise Rejection**



|     |  |
|-----|--|
| On  | Uses DC coupling with low sensitivity to reject noise. |
| Off | Noise rejection disabled                               |

## Use Advanced delay trigger

Advanced delay trigger is available only in 2CH models.

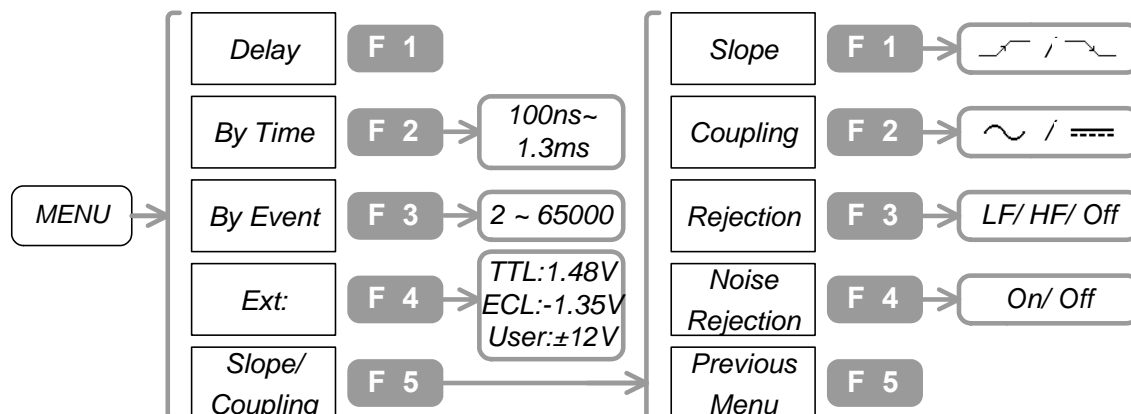
### Panel operation







1. Connect the start trigger signal to Channel1, and main signal to Channel2.
2. Press the Trigger menu key→F1. Press F1 until “Delay” appears.
3. To set the delay time, press F2. Then use the Variable knob .
4. To set the number of trigger event, press F3. Then use the Variable knob .
5. To set the triggering level of start signal, press F4 repeatedly. For user level, use the Variable knob .
6. To select the trigger slope, press F5, then press F1 repeatedly.
7. To select the coupling mode, press F2 repeatedly.
8. To select the frequency rejection mode, press F3 repeatedly.
9. To select the noise rejection mode, press F4 repeatedly.

**Range**                      **By Time** (Trigger delay time)  
 100ns ~ 1.3ms

**By Event**  
 2 ~ 65000

**Ext.** (Trigger level of the start signal)  
 TTL +1.4V  
 ECL -1.3V  
 USER ±12V range user defined level

**Slope**  
 Rising edge  
 Falling edge

**Coupling**  
 AC coupling  
 DC coupling

**(Frequency) Rejection**  
 LF Low Frequency rejection. Rejects frequency below 50kHz.  
 HF High Frequency rejection. Rejects frequency above 50kHz.  
 Off Rejection disabled

**Noise Rejection**  
 On Uses DC coupling with low sensitivity to reject noise.  
 Off Noise rejection disabled

**Example** Triggering occurs only after a pre-defined period of time (T)

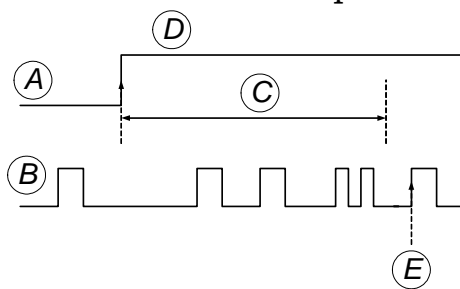

A: Start Trigger (External)  
 B: Main Trigger (CH1 or 2)  
 C: Set Time (T)  
 D: Trigger  
 E: Trigger point

Triggering occurs only after a pre-defined number of user event (three in this case)

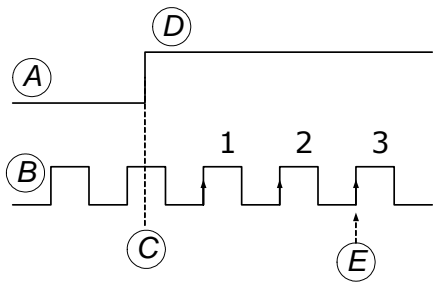

- A: Start Trigger (External)
- B: Main Trigger (CH1 or 2)
- C: Start point of External trigger count
- D: Trigger
- E: Trigger point

---

# Printout/ Data Transfer

---

---

|                 |  |    |
|-----------------|--|----|
| <b>Printout</b> | Printout display image .....               | 87 |
|                 | Printout display image (PC software) ..... | 88 |

---

|                     |  |    |
|---------------------|--|----|
| <b>Save/ Recall</b> | Quick save via USB .....                       | 89 |
|                     | Save image/ waveform/ setup .....              | 90 |
|                     | Configure folders and files in USB flash drive | 92 |
|                     | Recall waveform/ setup .....                   | 94 |
|                     | Recall default settings .....                  | 96 |

---

# Printout

## Printout display image (panel operation)

### Panel operation

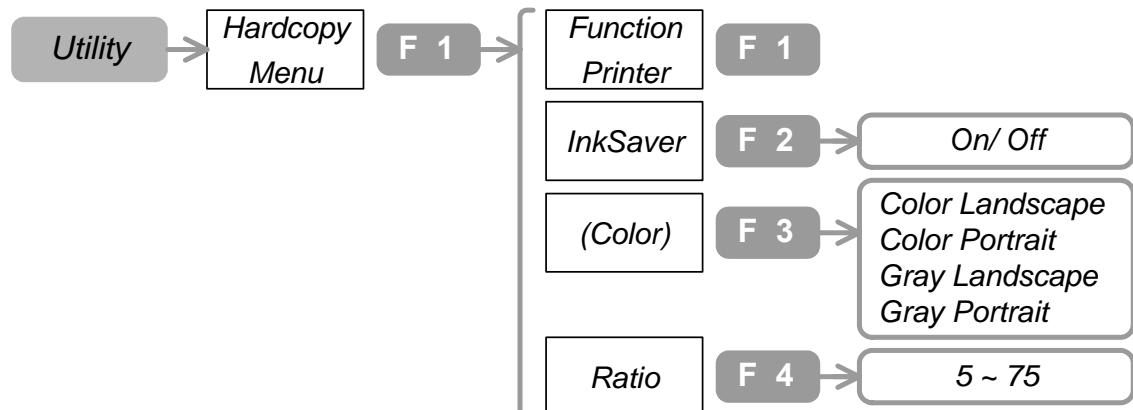

### HardCopy

1. Press Utility key→F1. Press F1 repeatedly until “Printer” appears.
2. To select the display background color, press F2 repeatedly.
3. To select the color and portrait, press F3 repeatedly.
4. To select the image size, press F4. Then use the Variable knob .
5. Connect the printer to the front or rear panel USB connector. (Make sure the other USB connector is not used. The two cannot work together at the same time.)

Front panel USB

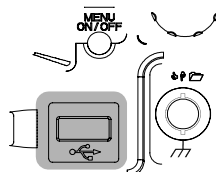

Rear panel USB



6. To start printing, press the Hardcopy key. (GDS-2000 remembers the printout setting. From the next

time, no need to configure the setting unless changed.)

**Range InkSaver (Display background color)**

On/ Off

InkSaver On

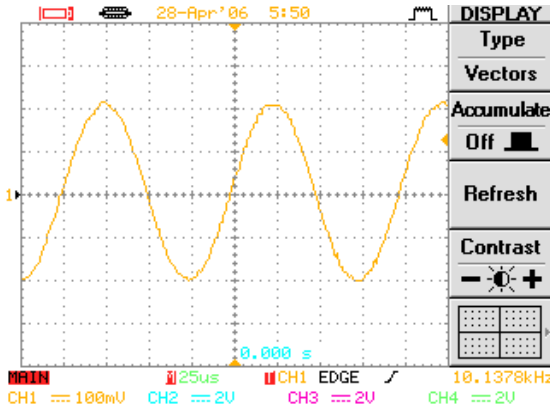

InkSaver Off

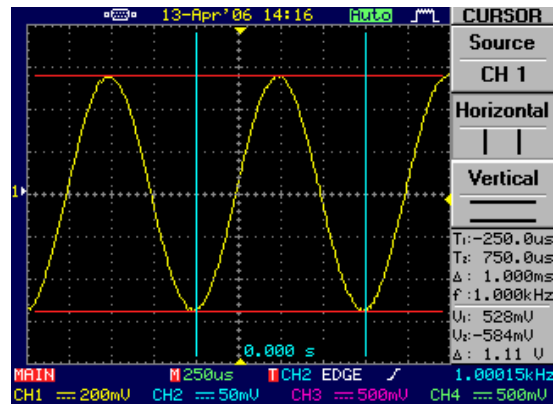

**Color/ Portrait**

- Color
- Landscape
- Color Portrait
- Gray
- Landscape
- Gray Portrait

**Ratio (Image size)**

5~75

**Confirmed Printers** The following printers have been confirmed.  
 HP Deskjet 970CXI  
 HP LaserJet 1010/ 1015/ 1300  
 Epson AL-C8600

**Printout display image (PC software)**

Use the printout function in the software. In this way, you can print out the image to any printer as long as your PC recognizes it. See page97 for software setup.



## Save/ Recall

### Quick save via USB flash drive

#### Panel operation

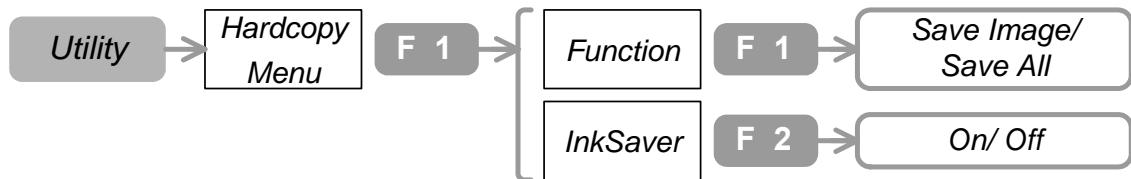

#### HardCopy

1. Press Utility key→F1.
2. To select the saved information, press F1 repeatedly.
3. To select the display background color, press F2 repeatedly.
4. Connect the USB flash drive to the front or rear panel USB connector. (Make sure the other USB connector is not used. The two cannot work together at the same time.)

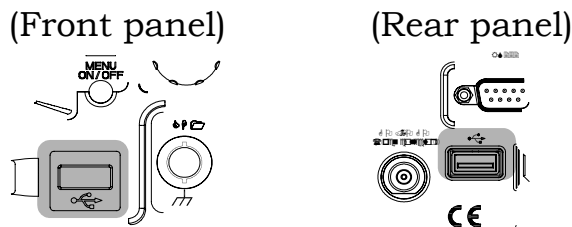



5. To store the information, press the Hardcopy key. (GDS-2000 remembers the printout setting. From the next time, no need to configure the setting unless changed.)

|              |  |   |
|--------------|--|---|
| <b>Range</b> | Image                                      | Saves the display image (GWxxxx.BMP).   |
|              | All  | Saves the following data in a folder (Allxxxx).<br>Display image: Axxx.BMP<br>Waveform: Axxx.CSV<br>Setup: Axxx.SET |
|              | <b>InkSaver (Display background color)</b> |   |
|              | On/Off                                     | For an example, see the previous page.  |

## Save image/ waveform/ setup

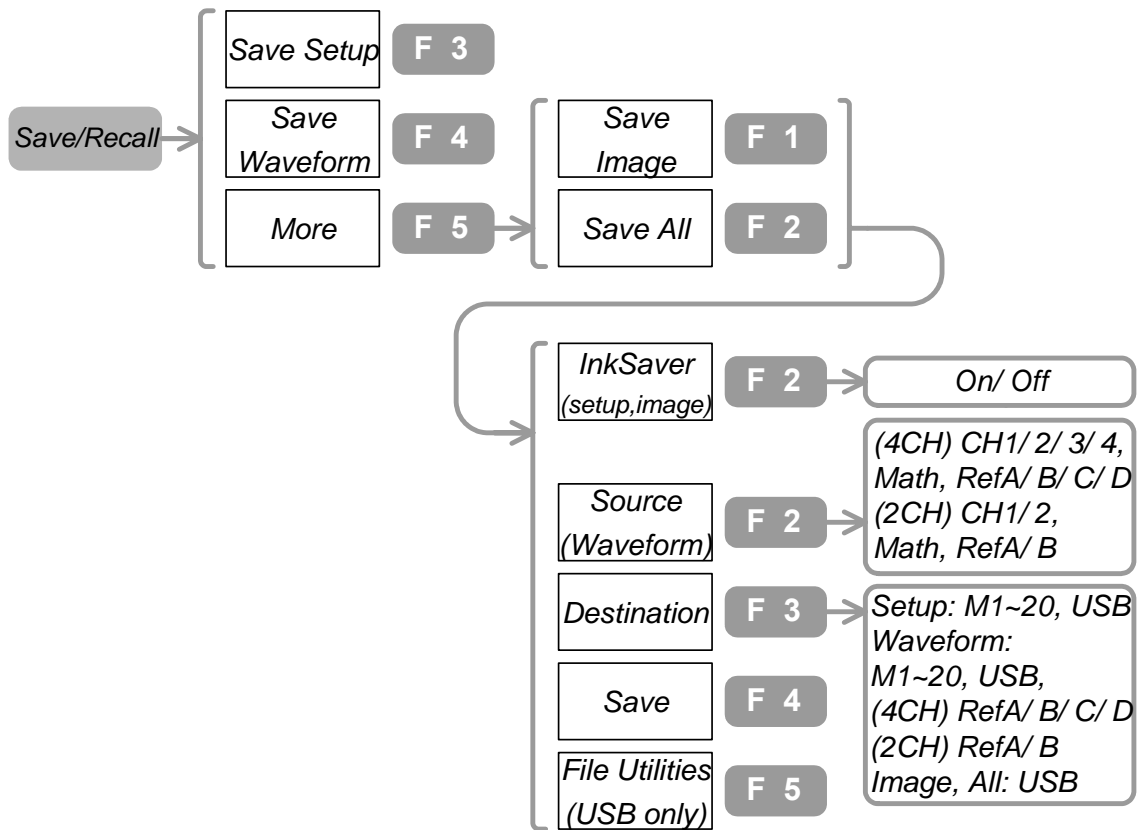
### Panel operation



1. Press Save/Recall key→F3 (Setup) or F4 (Waveform) or F5→F1 (Image) or F5→F2 (All).
2. (For Image and All) To select the display background color, press F2 repeatedly.
3. (For Waveform) To select the waveform source, press F2. Then use the Variable knob .
4. To select the location type, press F3 repeatedly. Then use the Variable knob .
5. (Storing to USB flash drive) Connect the USB flash drive to the front or rear panel USB connector. (Make sure the other USB connector is not used. The two cannot work together at the same time.)

Front panel  
USB

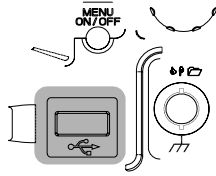

Rear panel  
USB

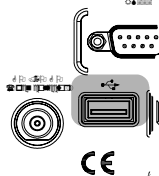

Save dialog screen

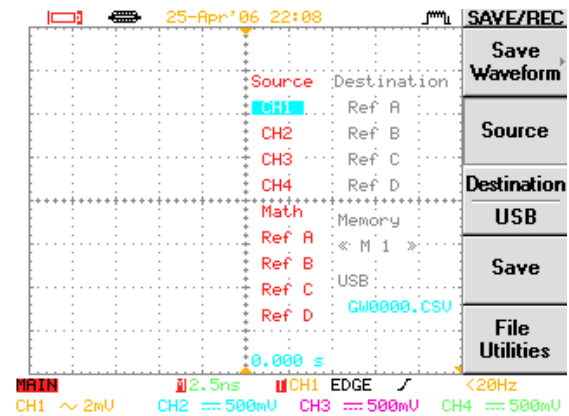

6. To save the file, press F4.

7. To configure USB folders, see page92.

Range

**File type**

|          |  |
|----------|--|
| Setup    | Setup file (Gxxx.SET).   |
| Waveform | Waveform file (Gxxx.CSV).  |
| Image    | Image file (Gxxx.BMP).   |
| All      | A folder (Axxx) containing setup (Axxx.SET), waveform (Axxx.CSV), and image file (Axxx.BMP). |

**InkSaver (Display background color)**

On/Off See page88 for the actual effect.

**Source**

CH1~CH4 Channel1 ~ Channel4 waveforms

MATH The waveform generated by math operations (page74).

RefA~D Reference waveforms A~D

**Destination**

RefA~D Reference waveforms A~D

Memory M1~M20 internal memory.

USB USB flash drive.

## Configure folders and files in USB flash drive

This part assumes you have connected a USB flash drive to GDS-2000 and have already selected F5 “File Utilities” in other save and recall menus.

### Panel operation

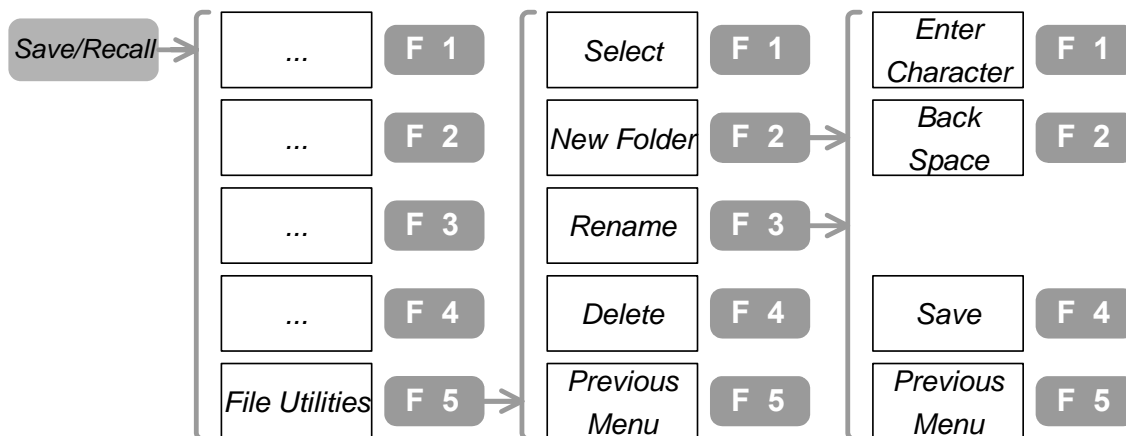

### See the folder contents

1. Use the Variable knob  to select the folder.
2. To enter the folder, press F1.
3. To go back to the previous level, select the root and press F1.

Root

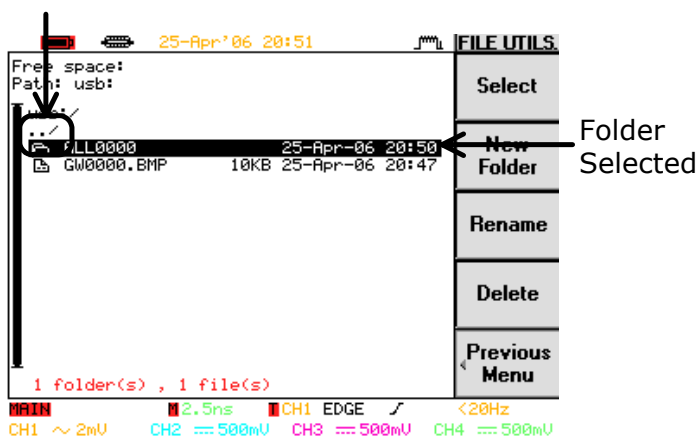

### Create a new folder & rename a file/folder

1. Press F2 (new folder) or F3 (rename a file or a folder). The editing screen appears.



2. To enter a character, select the letter using the Variable knob  and press F1.
3. To delete a character, press F2.
4. To save the result, press F4.

**Delete a file/folder**

1. Use the Variable knob  and move to the file or folder.
2. Press F4. Press again to confirm deletion.

## Recall waveform/ setup

### Panel operation

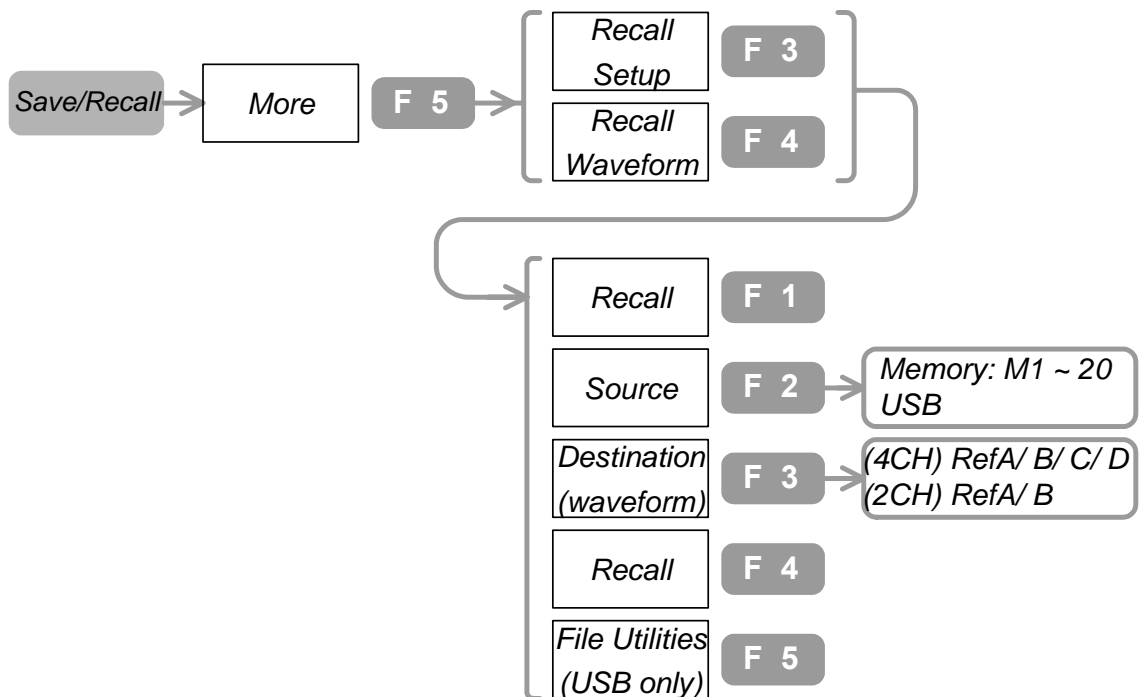

### Display the recalled waveform

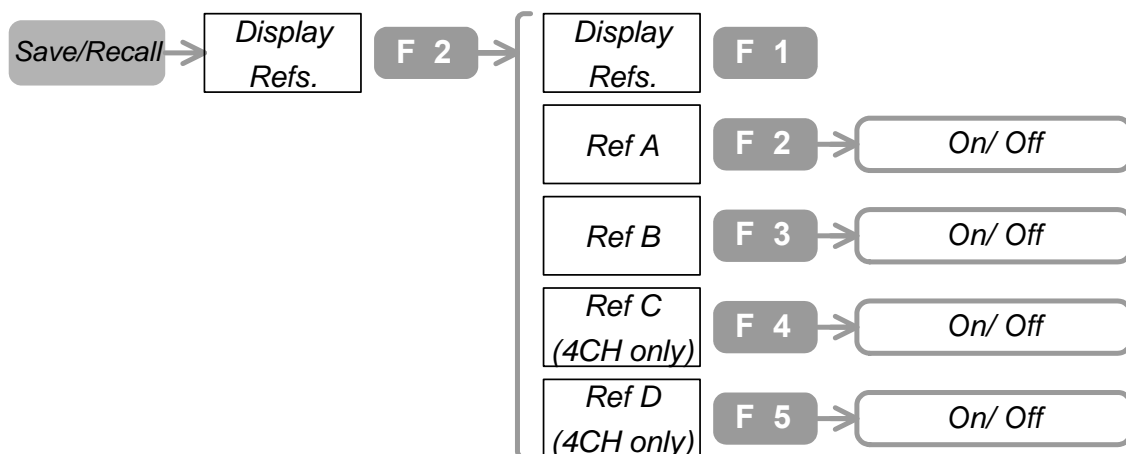

1. Press Save/Recall key→F5→F3 (setup)/ F4 (waveform).
2. To select the source, press F2 repeatedly.
3. To select the memory location, use the Variable knob .
4. (Recalling from USB flash drive) Connect the flash drive to the front or the rear USB connector. (Make sure the other USB

connector is not used. The two cannot work together at the same time.)

**Front panel USB**

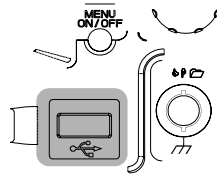

**Rear panel USB**

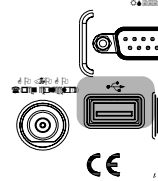

5. (Recalling waveforms) To select the destination (reference waveform), press F3 repeatedly.
6. To recall waveform/setup, press F4.
7. To configure USB folders, see page92.
8. (Showing the recalled waveform) Press Save/Recall key→F2. To show the waveform, select among F2~F4 and press it.

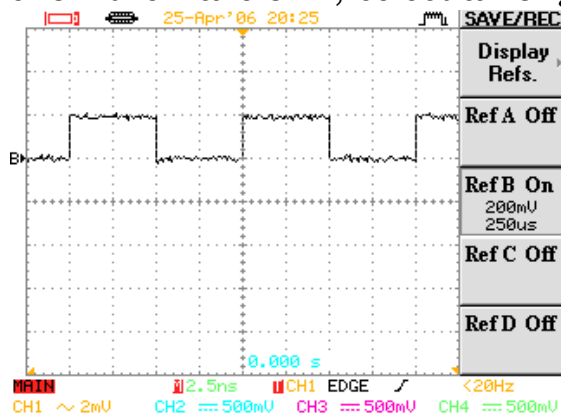

Ref B waveform recalled

| Range | File type                |  |
|-------|--------------------------|--|
|       | Waveform                 | Waveform file (xxxx.CSV).              |
|       | Setup                    | Panel setup file (xxxx.SET).           |
|       | <b>Source</b>            |  |
|       | Memory                   | M1~M20 internal memories               |
|       | USB                      | USB flash drive (Gxxx.SET)             |
|       | <b>Destination</b>       |  |
|       | Ref A/B/C/D (4CH models) | Reference waveforms stored internally. |
|       | Ref A/B (2CH models)     |  |

## Recall default settings

Panel Operation

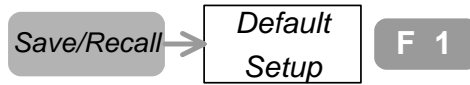

Press Save/Recall key→F1. GDS-2000 recalls the factory installed panel settings, listed below.

|                               |   |                                      |
|-------------------------------|---|--------------------------------------|
| <b>Acquisition</b>            | Mode: Normal  | Memory Length: 500                   |
| <b>Channel<br/>(Vertical)</b> | Scale: 2V/Div<br>Coupling: DC<br>BW Limit: Off                    | Invert: Off<br>Probe Attenuation: x1 |
| <b>Cursor</b>                 | Source: CH1<br>Vertical: None                                     | Horizontal: None                     |
| <b>Display</b>                | Type: dots<br>Graticule:  | Accumulate: Off                      |
| <b>Go-NoGo</b>                | Go-NoGo: Off<br>NoGo when:  | Source: CH1<br>Violating: Stop       |
| <b>Horizontal</b>             | Scale: 2.5us/Div  | Mode: Main Timebase                  |
| <b>Math</b>                   | Type: +<br>Position: 0.00 Div                                     | Channel: CH1+CH2<br>Unit/Div: 2V     |
| <b>Measure</b>                | Source1: CH1<br>Volt type: VPP<br>Delay type: FRR                 | Source2: CH2<br>Time Type: Frequency |
| <b>Program</b>                | Mode: Edit<br>Item: Memory  | Step: 1                              |
| <b>Trigger</b>                | Type: Edge<br>Mode: Auto<br>Coupling: DC<br>Noise Rejection : Off | Source: Channel1<br>Slope:           |
| <b>Utility</b>                | Hardcopy: SaveImage,<br>Inksaver Off<br>Sound: Off                | Interface: GPIB,<br>Address 8        |



# Remote Control

|                               |                                       |     |
|-------------------------------|---------------------------------------|-----|
| Use PC Software               | Configure the interface .....         | 97  |
|                               | Download and Install PC Software..... | 98  |
|                               | Setup and use the PC Software.....    | 99  |
| Use IEEE Based Remote control | Configure the interface .....         | 102 |
|                               | Command Syntax .....                  | 104 |
|                               | Command Set .....                     | 105 |

## Use PC Software

### Configure the interface

Panel operation



1. Press the Utility key→F2. To select the interface Press F1 repeatedly.
2. The interface icon appears on the top left side of the display.

Interface Icon

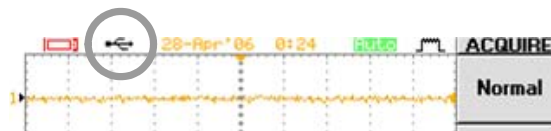

3. Connect the USB cable to the rear panel connector.

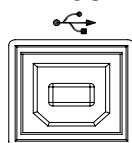

## Download and Install PC Software

**Software** Download the software from GWINSTEK website.

**Download**

1. Access [www.gwinstek.com.tw](http://www.gwinstek.com.tw).
2. Click the Download menu on the left task bar.



3. The Software download screen appears. Select Oscilloscope from the drop down menu.

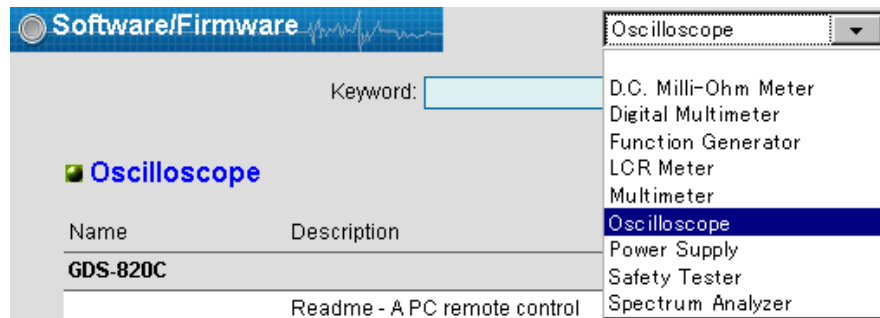

4. Click the PC software name under GDS-2000 section and download the software package to your local PC.

**Software**

**Installation**

1. Unpack the file.
2. Follow the instructions in **readme.txt**.

## Setup and use the PC Software

### Screen Description

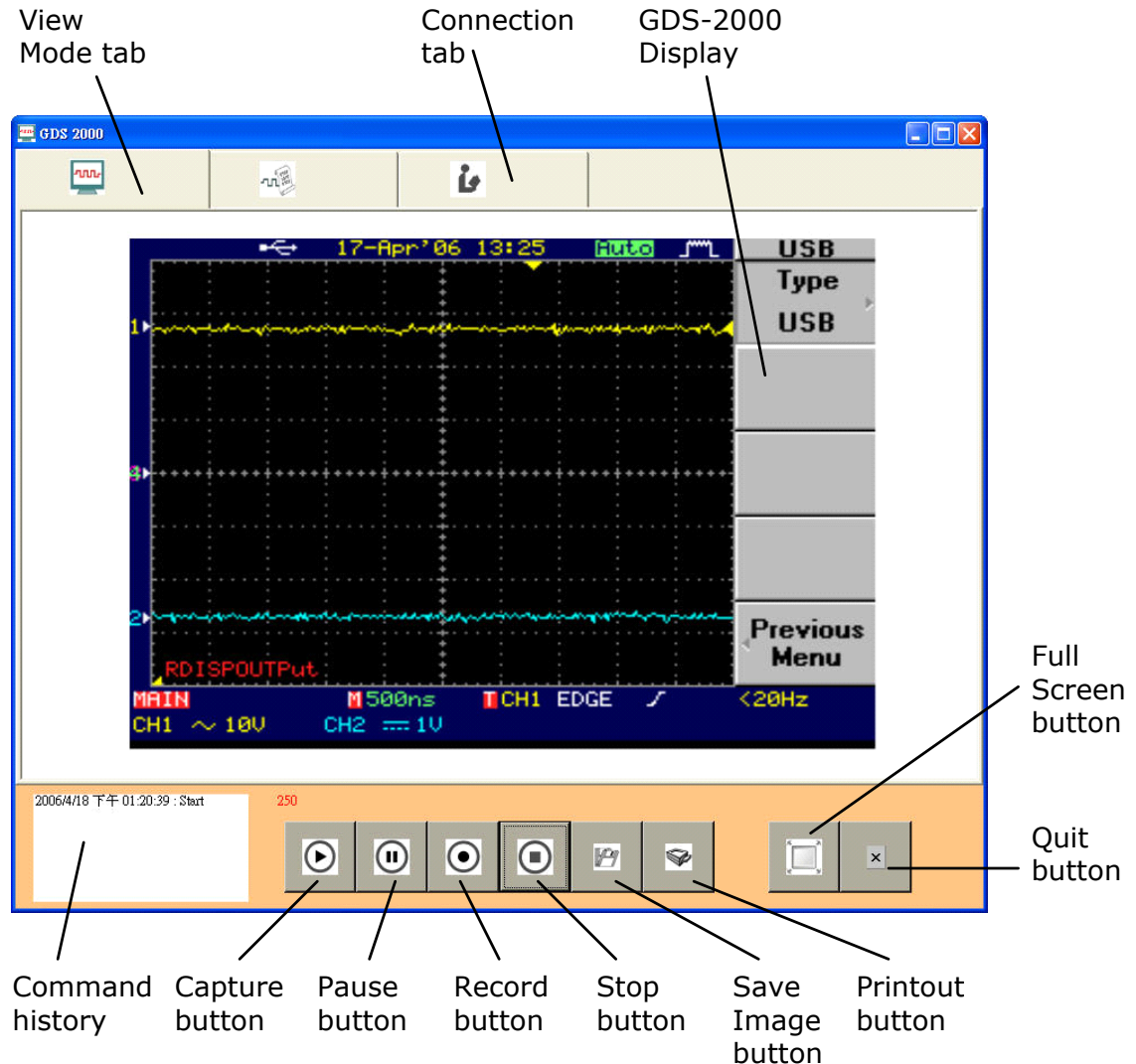

#### 1. Establish the connection

1. Install and activate the software. For details, see page98.
2. Configure and connect USB/RS232C cable. For details, see page97.
3. Click the Connection tab. Then click the Scan button. The oscilloscope ID appears, indicating the connection has been established.

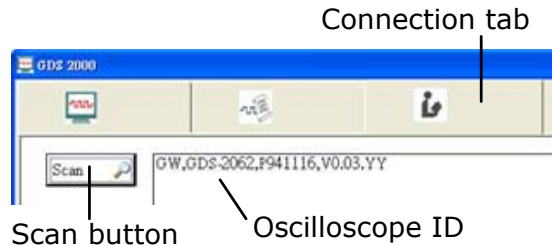

Oscilloscope ID format: (from left)  
 Manufacturer, Model No, Serial No, Firmware version

**2. Capture the waveform**

Click the Play mode tab. Then click the Play button. GDS-2000 display appears on the screen. Command history pane shows the record of issued commands.

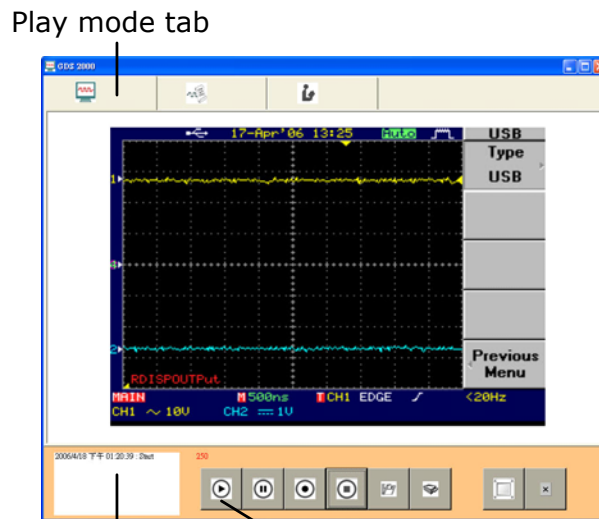

Command history pane      Play button

**3. Use the applications**

Start capturing the display

 Click the play button.

Pause capturing the display (freeze the display)

 Click the pause button.

Record the display video in \*.avi format

 Click the record button.

Stop capturing/ recording the display



Click the stop button.

---

Save the image in \*.gif/ \*.jpg/ \*.png/ \*.bmp/ \*.tif format



Click the save button. The save file windows appears.

---

Printout the captured image



Click the print button. The print window appears.

---

Show the oscilloscope display in full screen



Click the full screen button.

---

Quit the PC software



Click the quit button. Or...



Close the window directly.



---

# Use IEEE based remote control

## Configure the interface

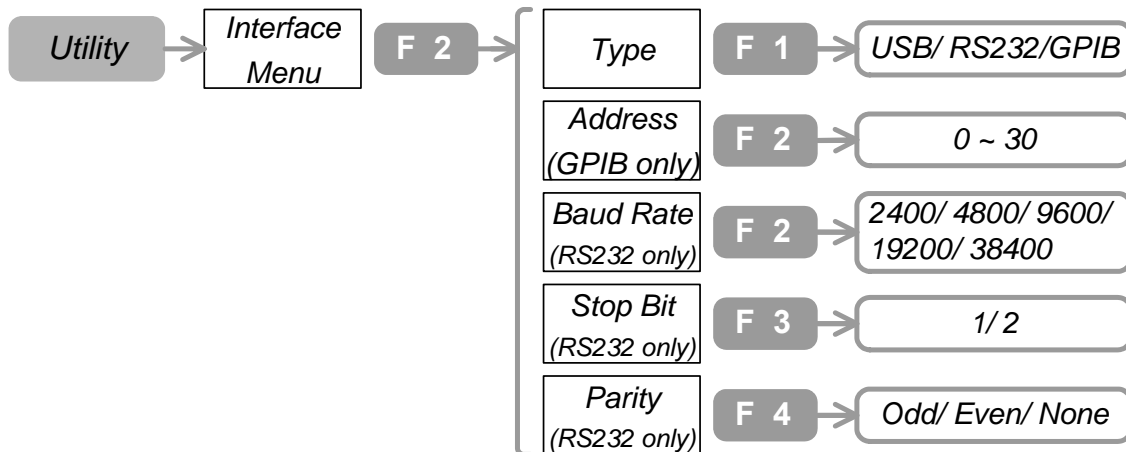
### Panel operation



1. Press the Utility key→F2. To select the interface Press F1 repeatedly.
2. The interface icon appears on the top left side of the display.  
 USB:   
 RS232C:   
 GPIB (Optional): 

Interface Icon

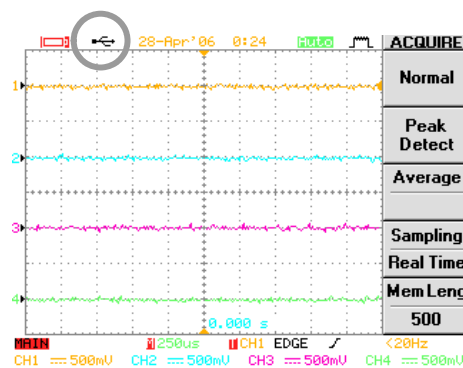

3. (For RS232C only) To configure RS232, press F2 (Baud rate), F3 (Stop Bit), and F4 (Parity) repeatedly.

4. (For GPIB only) To select the address, press F2 repeatedly.
5. Connect the USB/RS232C/ GPIB cable to the rear panel.

USB

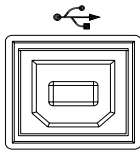

RS-232C

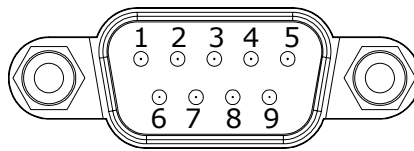

GPIB (Optional)

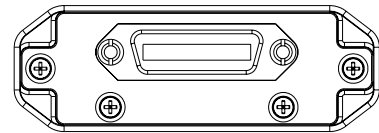

2: RxD, 3: TxD, 5: GND  
1, 4, 6~9: No connection

To install, power off the device and plug the GPIB card into the slot.

**Functionality Check**

Run this query command via a command terminal such as DOS prompt.

\*idn?

This should return the Manufacturer, Model number, Serial number, and Firmware version in the following format.

GW, GDS-2064, P920130, V3.01

**Range**

**Baud Rate (RS232C)**

2400, 4800, 9600, 19200, 38400

**Stop Bit (RS232C)**

1, 2

**Parity (RS232C)**

Odd/ Even/ None

**Address (GPIB)**

1~30

**GPIB Constraints**

- Keep these rules when using GPIB interface.
- \* Altogether less than 15 devices & 20m cable length, 2m between each device on the bus
  - \* Unique address assigned for each device
  - \* At least 2/3 of the GPIB devices turned On
  - \* No loop or parallel structure allowed

## Command Syntax

The commands are fully compatible with IEEE488.2 (1992) standard and partially compatible with SCPI (1994) standard.

**Example command**



- 1: Command Header
- 2: Single space
- 3: Parameter
- 4: Message Terminator OR Message Separator

**Command Header**

Several command header elements (nodes) can be concatenated to form a complex command. The above example can be separated into: TRIGger: (root node) + DELay: + MODE:

**Parameter example**

- <0/1>      0 or 1.
- <1~4>      Integer between 1, 2, 3, or 4.
- <0.01~5>    Decimal number between 0.01 and 5.
- <1e-9~5>    Floating number between 1e-9 and 5.
- < f >      Floating number without range.

**Message Terminator**

Marks the end of a command line. Any of the following is acceptable, in accordance with IEEE488.2 standard.

- LF^END      Line feed code (hexadecimal 0A) with END message
- LF            Line feed code
- <dab>^END    Last data byte with END message

**Message Separator**

; (semicolon)    Command separator.

trig



## Command Set

Commands are **non**-case sensitive.

For more detailed information, refer to the Programming Manual which is downloadable from [www.gwinstek.com.tw](http://www.gwinstek.com.tw).

### Acquisition

|                      |   |
|----------------------|---|
| :acq:aver?           | Returns the average number of waveform acquisition (available only for average mode).   |
| :acq:aver<br><2~256> | Sets the average number of waveform acquisition (available only for average mode).<br>Range: 2, 4, 8, 16, 32, 64, 128, 256                  |
| :acq:leng?           | Returns the memory length.<br>Range: 0 (500), 1 (5000), 2 (12500), 3 (25000)  |
| :acq:leng <0~3>      | Sets the memory length.<br>Range: 0 (500), 1 (5000), 2 (12500), 3 (25000)   |
| :acq:mod?            | Returns the acquisition mode.<br>Range: 0 (sample), 1 (peak detection), 2 (average)   |
| :acq:mod <0~2>       | Sets the acquisition mode.<br>Range: 0 (sample), 1 (peak detection), 2 (average)  |
| :acq<1~4>:mem<br>?   | Returns the whole waveform data for each channel. Format: #, data size, sample rate, channel, data. (select memory length in advance)       |
| :acq<1~4>:poin       | Returns the displayed range of waveform data (500 points) for each channel. Format: #, data size, horizontal scale, channel, waveform data. |

### Automatic measurements

|             |  |
|-------------|--|
| :aut        | Setup the horizontal, vertical, and trigger condition automatically (same as Auto Set functionality)       |
| :meas:fall? | Returns the first falling edge timing. (select the channel first)  |
| :meas:freq? | Returns the frequency. (select the channel first)  |
| :meas:nwid? | Returns the first negative pulse width timing. (select the channel first)                                  |
| :meas:pdut? | Returns the positive pulse width ratio. (select the channel first)<br>Range: 1~99 (in terms of percentage) |
| :meas:per?  | Returns the period value. (select the channel first)   |
| :meas:pwid? | Returns the positive pulse width. (select the  |

|                     |   |
|---------------------|---|
|                     | channel first)  |
| :meas:ris?          | Returns the first pulse rising edge timing. (select the channel first)                        |
| :meas:sour<br><1~4> | Sets the measurement channel.<br>Range: 1~4 (Channel1~Channel4)                               |
| :meas:vamp?         | Returns the voltage difference between positive and negative peak. (select the channel first) |
| :meas:vav?          | Returns the average voltage. (select the channel first)                                       |
| :meas:vhi?          | Returns the global high voltage. (select the channel first)                                   |
| :meas:vlo?          | Returns the global low voltage. (select the channel first)                                    |
| :meas:vmax?         | Returns the maximum amplitude. (select the channel first)                                     |
| :meas:vmin?         | Returns the minimum amplitude. (select the channel first)                                     |
| :meas:vpp?          | Returns the difference between maximum and minimum amplitude. (select the channel first)      |
| :meas:vrms?         | Returns the root mean square voltage. (select the channel first)                              |

### Cursor

|                          |   |
|--------------------------|---|
| :curs:x<1/2>p?           | Returns the horizontal cursor position.<br>Range: 1~249                                 |
| :curs:x<1/2>p<br><1~249> | Sets the horizontal cursor position.<br>Range: 1~249                                    |
| :curs:x<1/2>p?           | Returns the vertical cursor position.<br>Range: 1~199                                   |
| :curs:x<1/2>p<br><1~199> | Sets the vertical cursor position.<br>Range: 1~199                                      |
| :curs:xdel?              | Returns the difference between two horizontal cursors.<br>Range: 0.001~249              |
| :curs:ydel?              | Returns the difference between two vertical cursors.<br>Range: 0.001~199                |
| :curs:xdis<br><0/1>      | Enables or disables horizontal cursor.<br>Range: 0 (disable), 1 (enable)                |
| :curs:ydis<br><0/1>      | Enables or disables vertical cursor.<br>Range: 0 (disable), 1 (enable)                  |
| :curs:sour?              | Returns the source of the currently active cursor.<br>Range: 1~4 (channel1~4), 5 (math) |

---

|                     |  |
|---------------------|--|
| :curs:sour<br><1~5> | Sets the source of the currently active cursor.<br>Range: 1~4 (channel1~4), 5 (math) |
|---------------------|--|

---

### Display

---

|                      |  |
|----------------------|--|
| :refr                | Refreshes the display contents.  |
| :run                 | Runs the trigger (unfreezes the waveform).   |
| :stop                | Stops the trigger (freezes the waveform).  |
| :disp:acc?           | Returns the display accumulation status.<br>Range: 0 (disabled), 1 (enabled)               |
| :disp:acc <0/1>      | Enables or disables the display accumulation.<br>Range: 0 (disabled), 1 (enabled)          |
| :disp:cont?          | Returns the display contrast level.<br>Range: 0~20 (5% step)                               |
| :disp:cont<br><0~20> | Sets the display contrast level.<br>Range: 0~20 (5% step)                                  |
| :disp:grat?          | Returns the display graticule type.<br>Range: 0 (full grid), 1 (X and Y axis), 2 (no grid) |
| :disp:grat<br><0~2>  | Sets the display graticule type.<br>Range: 0 (full grid), 1 (X and Y axis), 2 (no grid)    |
| :disp:wav?           | Returns the waveform drawing style.<br>Range: 0 (vectors), 1 (dots)                        |
| :disp:wav<br><0/1>   | Sets the waveform drawing style.<br>Range: 0 (vectors), 1 (dots)                           |

---

### Go-No Go test

---

|                    |   |
|--------------------|---|
| :gon:cle           | Clears the Go-No Go test total number/ failure number counter on the display.                                       |
| :gon:exe <0/1>     | Starts or stops Go-No Go test.<br>Range: 0 (stop), 1 (start)  |
| :gon:func?         | Returns Go-No Go test status.<br>Range: 0 (disabled), 1 (enabled)   |
| :gon:func<br><0/1> | Enables or disables<br>Range: 0 (disabled), 1 (enabled)   |
| :gon:ngc?          | Returns the Go-No Go test total test count and fail count.  |
| :gon:ngd?          | Returns the No Go condition.<br>Range: 0 (No Go when template is not violated), 1 (No Go when template is violated) |
| :gon:ngd <0/1>     | Sets the No Go condition.<br>Range: 0 (No Go when template is not violated), 1 (No Go when template is violated)    |
| :gon:sour?         | Returns the Go-No Go test source channel.<br>Range: 0 (channel1), 1 (channel2)                                      |

---

|                             |   |
|-----------------------------|---|
| :gon:sour<br><0/1>          | Sets the Go-No Go test source channel.<br>Range: 0 (channel1), 1 (channel2)                                       |
| :gon:viol?                  | Returns the Go-No Go violation action.<br>Range: 0 (stop), 1 (stop + buzzer), 2 (continue), 3 (continue + buzzer) |
| :gon:viol <0~3>             | Sets the Go-No Go violation action.<br>Range: 0 (stop), 1 (stop + buzzer), 2 (continue), 3 (continue + buzzer)    |
| :temp<1~100>:<br>down?      | Returns the Go-No Go template data.<br>Range: 1~100   |
| :temp<1~100>:<br>upl        | Uploads the Go-No Go template data.<br>Range: 1~100   |
| :temp:max?                  | Returns the Go-No Go Max template number.   |
| :temp:max<br><1~100>        | Sets the Go-No Go Max template number.  |
| :temp:min?                  | Returns the Go-No Go Min template number.   |
| :temp:min<br><1~100>        | Sets the Go-No Go Min template number.  |
| :temp:mod?                  | Returns Go-No Go test template mode.<br>Range: 0 (Max or Min), 1 (Auto template)                                  |
| :temp:mod<br><0/1>          | Sets the Go-No Go test template mode.<br>Range: 0 (Max or Min), 1 (Auto template)                                 |
| :temp:pos:max?              | Returns the Go-No Go test Max template position.<br>Range: -300~300 (= -12~+12div, 1div=25dots)                   |
| :temp:pos:max<br><-300~300> | Sets the Go-No Go test Max template position.<br>Range: -300~300 (= -12~+12div, 1div=25dots)                      |
| :temp:pos:min?              | Returns the Go-No Go test Max template position.<br>Range: -300~300 (= -12~+12div, 1div=25dots)                   |
| :temp:pos:min<br><-300~300> | Sets the Go-No Go test Max template position.<br>Range: -300~300 (= -12~+12div, 1div=25dots)                      |
| :temp:tol?                  | Returns the Go-No Go test Auto template tolerance.<br>Range: 0.4~40 (percentage)                                  |
| :temp:tol<br><0.4~40>       | Sets the Go-No Go test Auto template tolerance.<br>Range: 0.4~40 (percentage)                                     |

**Horizontal scale**

|                |  |
|----------------|--|
| :tim:del?      | Returns the horizontal delay.  |
| :tim:del < f > | Sets the horizontal delay.   |
| :tim:scal?     | Returns the horizontal timebase (Tim/Div).<br>Range: 1e-9~10 (seconds) |
| :tim:scal      | Sets the horizontal timebase (Tim/Div).                                |

|                     |   |
|---------------------|---|
| <1e-9~10>           | Range: 1e-9~10 (seconds)  |
| :tim:swe?           | Returns the horizontal sweep mode.<br>Range: 0 (main timebase), 1 (window), 2 (window zoom), 3 (roll), 4 (XY) |
| :tim:swe <0~4>      | Sets the horizontal sweep mode.<br>Range: 0 (main timebase), 1 (window), 2 (window zoom), 3 (roll), 4 (XY)    |
| :tim:wind:del?      | Returns the position of the zoomed area.  |
| :tim:wind:del <f >  | Sets the position of the zoomed area.   |
| :tim:wind:scal?     | Returns the length of the zoomed area.  |
| :tim:wind:scal <f > | Sets the length of the zoomed area.   |

### Printout and data transfer

|                           |  |
|---------------------------|--|
| :prin                     | Printout the display contents.   |
| :wmem<1/2>:disp?          | Returns the waveform display status after being saved: wmem1 (RefA), wmem2 (RefB).<br>Range: 0 (disabled), 1 (enabled)         |
| :wmem<1/2>:dispc <0/1>    | Enables or disables displaying the waveform after being saved: wmem1 (RefA), wmem2 (RefB).<br>Range: 0 (disabled), 1 (enabled) |
| :wmem<1/2>:eras           | Erases the waveform after being saved.<br>Range: wmem1 (RefA), wmem2 (RefB).   |
| :wmem<1/2>:loc <-200~200> | Sets the position of the stored waveform: wmem1 (RefA), wmem2 (RefB).<br>Range: -200~200                                       |
| :wmem<1/2>:ofs <-100~100> | Sets the offset of the stored waveform: wmem1 (RefA), wmem2 (RefB).<br>Range: -100~100   |
| :wmem<1/2>:save <0~4>     | Saves the waveform: wmem1 (RefA), wmem2 (RefB).<br>Range: 0~3 (channel1~channel4), 4 (math)                                    |

### Trigger

|                             |   |
|-----------------------------|---|
| :trig:coup?                 | Returns the trigger coupling mode.<br>Range: 0 (AC coupling), 1 (DC coupling) |
| :trig:coup <0/1>            | Sets the trigger coupling mode.<br>Range: 0 (AC coupling), 1 (DC coupling)    |
| :trig:del:tim?              | Returns the user-defined trigger delay time.<br>Range: 1e-7~1.3e-3            |
| :trig:del:tim <1e-7~1.3e-3> | Sets the user-defined trigger delay time.<br>Range: 1e-7~1.3e-3               |

|                             |  |
|-----------------------------|--|
| :trig:del:even?             | Returns the user-defined trigger delay event count.<br>Range: 2~65000  |
| :trig:del:even <2~65000>    | Sets the user-defined trigger delay event count.<br>Range: 2~65000   |
| :trig:del:lev?              | Returns the user-defined trigger signal level.<br>Range: -12~12  |
| :trig:del:lev <-12~12 (f) > | Sets the user-defined trigger signal level.<br>Range: -12~12 (floating point)  |
| :trig:del:mod?              | Returns the trigger signal level.<br>Range: 0 (TTL), 1 (ECL), 2 (USR)  |
| :trig:del:mod <0~2>         | Sets the trigger signal level.<br>Range: 0 (TTL), 1 (ECL), 2 (USR)   |
| :trig:del:typ?              | Returns the delay trigger mode.<br>Range: 0 (time driven), 1 (event driven)  |
| :trig:del:typ <0/1>         | Sets the delay trigger mode.<br>Range: 0 (time driven), 1 (event driven)   |
| :trig:freq?                 | Returns the trigger frequency.   |
| :trig:lev?                  | Returns the trigger level.   |
| :trig:lev < >               | Sets the trigger level.  |
| :trig:mod?                  | Returns the trigger mode.<br>Range: 0 (auto level), 1 (auto), 2 (normal), 3 (single)   |
| :trig:mod <0~3>             | Sets the trigger mode.<br>Range: 0 (auto level), 1 (auto), 2 (normal), 3 (single)  |
| :trig:nrej?                 | Returns the trigger noise rejection status.<br>Range: 0 (disabled), 1 (enabled)  |
| :trig:nrej <0/1>            | Sets the trigger noise rejection status.<br>Range: 0 (disabled), 1 (enabled)   |
| :trig:puls:mod?             | Returns the pulse trigger mode.<br>Range: 0 (<), 1 (>), 2 (=), 3 (≠)   |
| :trig:puls:mod <0~3>        | Sets the pulse trigger mode.<br>Range: 0 (<), 1 (>), 2 (=), 3 (≠)  |
| :trig:puls:tim?             | Returns the trigger pulse width time.  |
| :trig:puls:tim < f >        | Sets the trigger pulse width time.   |
| :trig:rej?                  | Returns the trigger frequency reject status.<br>Range: 0 (disabled), 1 (low frequency rejected), 2 (high frequency rejected) |
| :trig:rej <0~2>             | Sets the trigger frequency reject status.<br>Range: 0 (disabled), 1 (low frequency rejected), 2 (high frequency rejected)    |
| :trig:slop?                 | Returns the trigger slope type.<br>Range: 0 (rising edge), 1 (falling edge)  |

|                                |   |
|--------------------------------|---|
| :trig:slop <0/1>               | Sets the trigger slope type.<br>Range: 0 (rising edge), 1 (falling edge)      |
| :trig:sour?                    | Returns the trigger source.<br>Range: 0~3 (channel1~4), 4 (external), 5(line) |
| :trig:sour <0~5>               | Sets the trigger source.<br>Range: 0~3 (channel1~4), 4 (external), 5(line)    |
| :trig:typ?                     | Returns the trigger type.<br>Range: 0 (edge), 1 (video), 2 (pulse), 3 (delay) |
| :trig:typ <0~3>                | Sets the trigger type.<br>Range: 0 (edge), 1 (video), 2 (pulse), 3 (delay)    |
| :trig:vid:fiel?                | Returns the video trigger field.<br>Range: 0 (line), 1 (field1), 2 (field2)   |
| :trig:vid:fiel<br><0~2>        | Sets the video trigger field.<br>Range: 0 (line), 1 (field1), 2 (field2)      |
| :trig:vid:lin?                 | Returns the video trigger line.<br>Range: 1~263 (NTSC), 1~313 (SECAM, PAL)    |
| :trig:vid:lin<br><1~263 (313)> | Sets the video trigger line.<br>Range: 1~263 (NTSC), 1~313 (SECAM, PAL)       |
| :trig:vid:pol?                 | Returns the video trigger polarity.<br>Range: 0 (positive), 1 (negative)      |
| :trig:vid:pol<br><0/1>         | Sets the video trigger polarity.<br>Range: 0 (positive), 1 (negative)         |
| :trig:vid:typ?                 | Returns the video trigger TV system.<br>Range: 0 (PAL), 1 (NTSC), 2 (SECAM)   |
| :trig:vid:typ<br><0~2>         | Sets the video trigger TV system.<br>Range: 0 (PAL), 1 (NTSC), 2 (SECAM)      |

### Verical scale, Math

|                           |   |
|---------------------------|---|
| :chan<1~4>:bwl<br>?       | Returns the bandwidth limit status for each channel.<br>Range: 0 (limit Off), 1 (limit On)                  |
| :chan<1~4>:bwl<br><0~1>   | Enables/disables the bandwidth limit for each channel.<br>Range: 0 (limit Off), 1 (limit On)                |
| :chan<1~4>:cou<br>p?      | Returns the coupling mode for each channel.<br>Range: 0 (AC coupling), 1 (DC coupling), 2 (Ground coupling) |
| :chan<1~4>:cou<br>p <0~2> | Sets the coupling mode for each channel.<br>Range: 0 (AC coupling), 1 (DC coupling), 2 (Ground coupling)    |
| :chan<1~4>:dis<br>p?      | Returns the active status for each channel.<br>Range: 0 (disabled), 1 (enabled)                             |
| :chan<1~4>:dis<br>p <0~1> | Enables or disables each channel.<br>Range: 0 (disabled), 1 (enabled)                                       |



|                             |   |
|-----------------------------|---|
| :chan<1~4>:inv ?            | Returns the invert status for each channel.<br>Range: 0 (no change), 1 (inverted)   |
| :chan<1~4>:inv <0~1>        | Inverts each channel.<br>Range: 0 (no change), 1 (inverted)   |
| :chan<1~4>:math <0~3>       | Sets the math operation for each channel.<br>Range: 0 (Add), 1 (Subtract), 2 (Multiplication), 3 (Division), 4 (FFT), 5 (Off) |
| :chan<1~4>:offset ?         | Returns the offset voltage (Volt) for each channel.<br>Range: 0.001~5   |
| :chan<1~4>:offset <0.001~5> | Sets the offset voltage (Volt) for each channel.<br>Range: 0.001~5 (depends on scale)   |
| :chan<1~4>:prob ?           | Returns the probe attenuation factor for each channel.<br>Range: 0 (x1), 1 (x10), 2 (x100)                                    |
| :chan<1~4>:prob <0~2>       | Sets the probe attenuation factor for each channel.<br>Range: 0 (x1), 1 (x10), 2 (x100)                                       |
| :chan<1~4>:scale ?          | Returns the vertical scale (Volt/Div) for each channel.<br>Range: 0.002~5   |
| :chan<1~4>:scale <0.002~5>  | Sets the vertical scale (Volt/Div) for each channel.<br>Range: 0.002~5  |

### Registers manipulation

|              |  |
|--------------|--|
| *cls         | Clears all event status registers (Output Queue, Operation Event Status, Questionable Event Status, Standard Event Status)   |
| *ese?        | Returns the ESER (Event Status Enable Register) contents.<br>Example: 130→means ESER=10000010                                |
| *ese <0~255> | Sets the ESER contents.<br>Example: *ese 65→sets ESER to 01000001  |
| *esr?        | Returns and clears the SESR (Standard Event Status Register) contents.<br>Example: 198→means SESR=11000110                   |
| *idn?        | Returns the oscilloscope ID as Manufacturer, Model No, Serial No, Firmware version.<br>Example: GW, GDS-2064, P920130, V3.01 |
| *lrm?        | Returns the oscilloscope settings as strings.  |
| *opc?        | “1” is placed in the output queue when all the pending operations are completed.   |
| *opc         | Sets the operation complete bit (bit0) in SERS   |



---

|              |  |
|--------------|--|
|              | (Standard Event Status Register) when all the pending operations are completed.                |
| *rcl <1~15>  | Recalls the panel setup from internal memory.<br>Example: *RCL 1→recalls setup from memory1    |
| *rst         | Recalls the default panel setup (reset the device).  |
| *sav <1~15>  | Saves the panel setup to internal memory.<br>Example: *SAV 1→saves setup to memory1            |
| *sre?        | Returns the SRER (Service Request Enable Register) contents.<br>Example: 3→means SRER=00000011 |
| *sre <0~255> | Sets the SRER contents.<br>Example: *SRE 7→SRER=00000111                                       |
| *stb?        | Returns the SBR (Status Byte Register) contents.<br>Example: 81→means SBR=01010001             |
| *wai         | Prevents execution of further commands until all the pending operations are completed.         |

---

# Calibration

## Calibrate the vertical scale

\*Run Calibration under two conditions.

1 When using GDS-2000 in a new environment, such as field measurement.

2 When the temperature changes more than 5°C.

\* Trigger Level and Delay Time calibration are available only for the service personnel.

### Panel operation

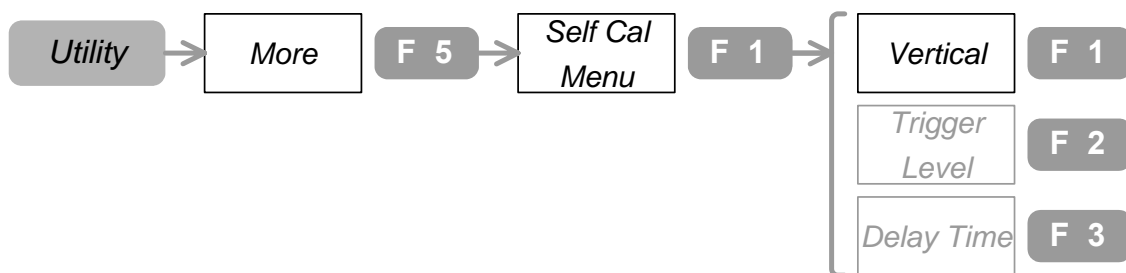

1. Make sure the environment fits these conditions.  
Temperature:  $26 \pm 5^{\circ}\text{C}$ , Relative humidity:  $\leq 80\%$
2. Connect the rear panel Calibration output to Channel1. (BNC male – male connector)

### Calibration Output



### Connect to Channel1

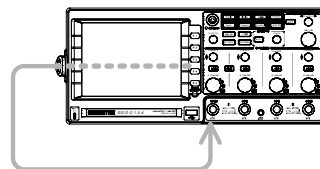

3. Press the Utility key→F5→F1.
4. Press F1, which calibrates the vertical scale.
5. Press F5 and start the calibration (approx. 2 minutes).
6. When completed, switch the connection to channel 2. Repeat the above process for the whole channel.

## Compensate the probe

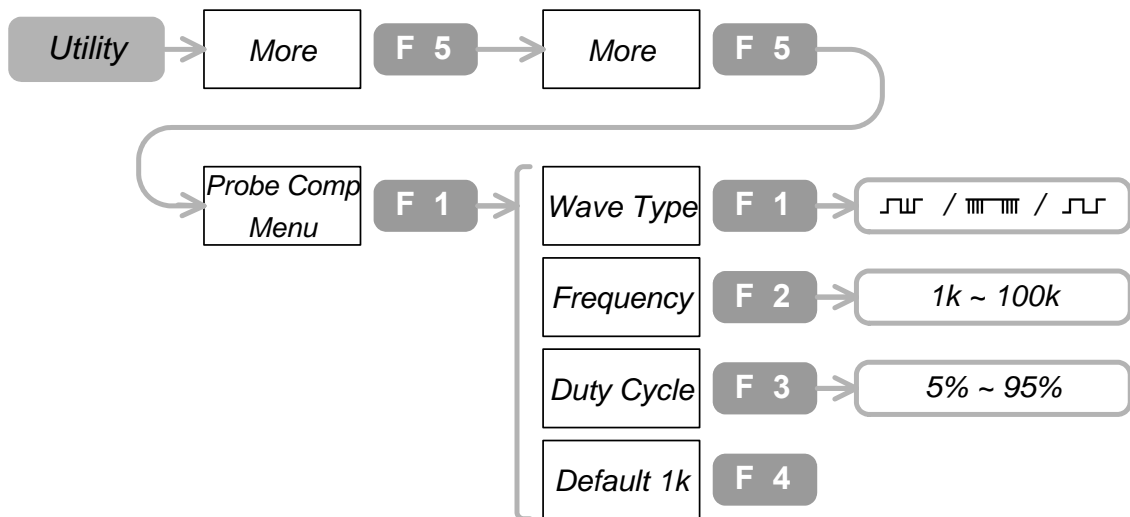

Run probe compensation when using it for the first time.

### Panel operation



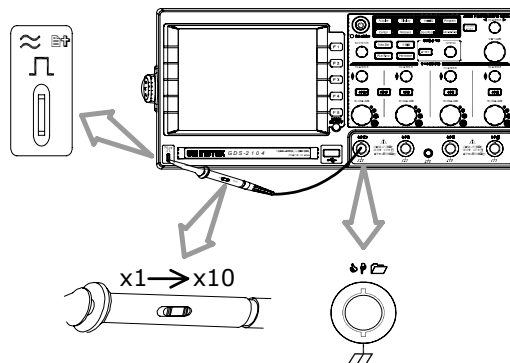

1. Connect the probe to Channel1 and reference signal output.

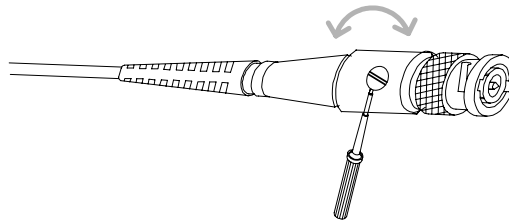
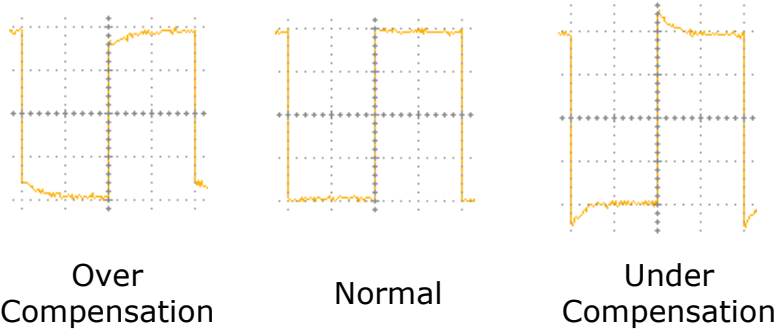

2. Press Utility key→F5→F5→F1→F1. Press F1 again and select the wave type  $\square$ .
3. Press F2. Use Variable knob  and set the frequency.
4. Press F3. Use Variable knob  and set the Duty cycle.
5. Compensate the probe viewing the waveform shape.



|              |   |   |
|--------------|---|---|
| <b>Range</b> | <b>Wave type</b>  |   |
|              |    | Probe compensation signal, 2Vpp at x10 probe attenuation.           |
|              |    | Demonstration signal for showing the effects of deep memory length. |
|              |  | Demonstration signal for showing the effects of peak detection.     |
|              | <b>Frequency</b>  |   |
|              | 1k~100k   | 1k step.  |
|              | <b>Duty Cycle</b>   |   |
|              | 5%~95%  | 5% step.  |

---

## FAQ

---

- I pressed the Power (On/Standby) key on the front panel but nothing happens.
  - The probe waveform is distorted.
  - I connected the signal but it does not appear on screen.
  - Autoset does not catch the signal well.
  - I want to clean up the cluttered panel settings.
  - The display image printout is too dark on the background.
  - I want to install the optional battery pack. I put the battery pack in but it is not working.
  - The date and time setting is not correct.
  - USB does not work.
  - The accuracy does not match the specification.
- 

I pressed the Power (On/Standby) key on the front panel but nothing happens.

Make sure you turned on the rear panel Power switch. For details, see page 14.

Note that after proper sequence, it takes around 15~20 seconds for the display to become active.

---

The probe waveform is distorted.

You might need to compensate the probe. For details, see page 15. Note that the frequency accuracy and duty factor are not specified for probe compensation waveform and therefore it should not be used for other reference purpose.

---

I connected the signal but it does not appear on screen.

Make sure you have activated the channel by pressing the channel key  (the LED lights).

Autoset does not catch the signal well.

Autoset function cannot catch signals under 30mV or 30Hz. Please use the manual operation.

---

I want to clean up the cluttered panel settings.

Recall the default settings by pressing Save/Recall key→F1. For details, see page96.

---

The display image printout is too dark on the background.

Use the Inksaver function: it reverses the display background and waveform color. For details, see page87, 89.

---

I want to install the optional battery pack.

I put the battery pack in but it is not working.

The battery pack needs additional internal components to work properly. They are factory installed items: contact your dealer.

---

The date and time setting is not correct.

For setting them, please see page61. If it does not help, the internal battery controlling the clock might be worn out. Contact your service dealer or GWInstek.

---

USB does not work.

Make sure you are not using the front and the rear USB connector at the same time. Disconnect either of the USB device and try again.

---

The accuracy does not match the specification.

Make sure the device is powered on for at least 30 minutes, within +20°C~+30°C, which is necessary to stabilize the unit to match the specification.

---

If there is still a problem, please contact your local dealer or GWInstek at [www.gwinstek.com.tw](http://www.gwinstek.com.tw) / [marketing@goodwill.com.tw](mailto:marketing@goodwill.com.tw).

# Appendix

## Specifications

The specifications apply under the following conditions: GDS-2000 is powered on for at least 30 minutes, within +20°C~+30°C.

|                  | <b>GDS-2062/64</b> | <b>GDS-2102/04</b>  | <b>GDS-2202/04</b>  |
|------------------|--------------------|---------------------|---------------------|
| <b>Channels</b>  | 2/4                | 2/4                 | 2/4                 |
| <b>Bandwidth</b> | DC~60MHz<br>(-3dB) | DC~100MHz<br>(-3dB) | DC~200MHz<br>(-3dB) |
| <b>Rise Time</b> | 5.8ns approx.      | 3.5ns approx.       | 1.75ns approx.      |

### GDS-2062/2064/2102/2104/2202/2204

|                 |                         |  |
|-----------------|-------------------------|--|
| <b>Vertical</b> | Sensitivity             | 2mV/div~5V/Div (1-2-5 increments)  |
|                 | Accuracy                | ± (3% x  Readout +0.05div x Volts/div)   |
|                 | Input Coupling          | AC, DC, & Ground   |
|                 | Input Impedance         | 1MΩ±2%, ~16pF  |
|                 | Polarity                | Normal & Invert  |
|                 | Maximum Input           | 300V (DC+AC peak), CATII   |
|                 | Waveform Signal Process | +, -, x, ÷, FFT  |
|                 | Offset Range            | 2mV/div~20mV/div: ±0.5V<br>50mV/div~200mV/div: ±5V<br>500mV/div~2V/div: ±50V<br>5V/div: ±300V        |
|                 | Bandwidth Limit         | 20MHz (-3dB)   |
|                 | <b>Trigger</b>          | Sources  |
| Modes           |                         | Auto-Level, Auto, Normal, Single, TV, Edge, Pulse Width, Time-Delay, Event-Delay(for 2ch model only) |
| Coupling        |                         | AC, DC, LFrej, HFrej, Noise rej  |
| Sensitivity     |                         | DC~25MHz: Approx. 0.5div or 5mV  |

|   |                               |   |
|---|-------------------------------|---|
|   |                               | 25MHz~max: Approx. 1div or 10mV   |
| <b>Ext Trigger (for 2ch model only)</b> | Range                         | ±15V  |
|   | Sensitivity                   | DC~30MHz: ~50mV<br>30MHz~max: ~100mV  |
|   | Input Impedance               | 1MΩ±2%, ~16pF   |
|   | Maximum Input                 | 300V (DC + AC peak), CATII  |
| <b>Horizontal</b>                       | Range                         | ±15V  |
|   | Modes                         | Main, Window, Window Zoom, Roll, X-Y  |
|   | Accuracy                      | ±0.01%  |
|   | Pre-Trigger                   | 20 div maximum  |
|   | Post-Trigger                  | 1000 div  |
| <b>X-Y Mode</b>                         | X-Axis Input                  | Channel 1   |
|   | Y-Axis Input                  | Channel 2   |
|   | Phase Shift                   | ±3 at 100kHz  |
| <b>Signal Acquisition</b>               | Real-Time                     | 1G Sa/s maximum   |
|   | Equivalent                    | 25G Sa/s maximum  |
|   | Vertical                      | 8 bits  |
|   | Resolution                    |   |
|   | Record Length                 | 25K Dots Maximum  |
|   | Single Shot                   | 100MHz  |
|   | Bandwidth                     |   |
|   | Acquisition Mode              | Sample, Peak Detect, Average, Accumulate  |
|   | Peak Detection                | 10ns  |
| Average                                 | 2, 4, 8, 16, 32, 64, 128, 256 |   |
| <b>Cursors and Measurement</b>          | Voltage                       | Vpp, Vamp, Vavg, Vrms, Vhi, Vlo, Vmax, Vmin, Rise Preshoot/ Overshoot, Fall Preshoot/ Overshoot |
|   | Time                          | Freq, Period, Rise Time, Fall Time, Positive Width, Negative Width, Duty Cycle                  |
|   | Delay                         | FRR, FRF, FFR, FFF, LRR, LRF, LFR, LFF  |
|   | Cursors                       | Voltage difference (ΔV)<br>Time difference (ΔT)   |
|   | Auto Counter                  | Resolution: 6 digits  |



|                               |                          |  |
|-------------------------------|--------------------------|--|
|                               |                          | Accuracy: $\pm 2\%$<br>Signal source: All available trigger source except the Video trigger                              |
| <b>Control Panel Function</b> | Auto Set                 | Automatically adjust vertical Volt/div, Horizontal Time/div, and Trigger level   |
|                               | Save Setup               | Internal memory: 20 sets<br>USB Flash drive: unlimited   |
|                               | Save Waveform + Template | Internal memory: 20 sets<br>USB Flash drive: unlimited   |
| <b>Display</b>                | LCD                      | 5.6 inch, TFT, brightness adjustable   |
|                               | Resolution (dots)        | 234 (Vertical) x 320 (Horizontal)  |
|                               | Graticule                | 8 x 10 divisions (menu On)<br>8 x 12 divisions (menu Off)  |
| <b>Interface</b>              | Go-No Go Output          | Open collector   |
|                               | RS-232C                  | DTE DB 9-pin male  |
|                               | GPIB (Optional)          | IEEE488.2 24-pin female  |
|                               | USB                      | Host: Flash drive, Printer<br>Device: Remote control   |
| <b>Power Source</b>           | Line Voltage             | 100V~240V AC, 48Hz~63Hz  |
|                               | Battery (Optional)       | 10.8V Li-Ion pack, 6600mAh per pack<br>12hour charge time (from AC line)<br>3 hour operating time (depend on conditions) |
| <b>Miscellaneous</b>          | Language Selection       | English, Chinese (Traditional), Chinese (Simplified), Russian  |
|                               | On-Line Help             |  |
|                               | Real-Time Clock          | Display: yy/mm/dd/hh/ss<br>(time stamp for saved data)   |
| <b>Dimensions</b>             | 254D x 142H x 310W (mm)  |  |
| <b>Weight</b>                 | Approx. 4.3kg            |  |
| <b>Temperature</b>            | Operating                | 0°C~50°C   |
|                               | Storage                  | -20°C~70°C   |
| <b>Humidity</b>               | Operating                | 80% R.H. @35°C   |
|                               | Storage                  | 80% R.H. @70°C   |

## Declaration of Conformity

We  
 GOOD WILL INSTRUMENT CO., LTD.  
**No. 95-11, Pao-Chung Rd., Hsin-Tien City, Taipei Hsien, Taiwan**  
**GOOD WILL INSTRUMENT (SUZHOU) CO., LTD.**  
**No. 69, Lushan Road, Suzhou New District Jiangsu, China**  
**declare that the below mentioned product**  
 GDS-2000  
**is herewith confirmed to comply with the requirements set out in the Council Directive on the Approximation of the Law of Member States relating to Electromagnetic Compatibility (89/336/EEC, 92/31/EEC, 93/68/EEC) and Low Voltage Equipment Directive (73/23/EEC, 93/68/EEC). For the evaluation regarding the Electromagnetic Compatibility and Low Voltage Equipment Directive, the following standards were applied:**

© EMC

|  |   |
|--|---|
| EN 61326-1: Electrical equipment for measurement, control and laboratory use — EMC requirements (1997+A1: 1998+A2: 2001) |   |
| Conducted and Radiated Emissions<br>EN 55011: 1998 class A   | Electrostatic Discharge<br>EN 61000-4-2: 1995+A1:1998 |
| Current Harmonic<br>EN 61000-3-2: 2000   | Radiated Immunity<br>EN 61000-4-3: 1996+A1:1998       |
| Voltage Fluctuation<br>EN 61000-3-3: 1995  | Electrical Fast Transients<br>EN 61000-4-4: 1995      |
| -----  | Surge Immunity<br>EN 61000-4-5: 1995                  |
| -----  | Conducted Susceptibility<br>EN 61000-4-6: 1996        |
| -----  | Power Frequency Magnetic Field<br>EN 61000-4-8 : 1993 |
| -----  | Voltage Dips/ Interrupts<br>EN 61000-4-11: 1994       |

© Safety

|  |
|--|
| Low Voltage Equipment Directive 73/23/EEC & amended by 93/68/EEC |
| <b>Safety Requirements</b>                                       |
| <b>IEC/EN 61010-1: 2001</b>                                      |

# Index

- A**
- acquisition ..... 41
  - Auto set
    - configuration ..... 65
    - FAQ ..... 117
    - functionality check ..... 16
  - automatic measurement
    - configuration ..... 66
    - view result ..... 69
- B**
- battery
    - FAQ ..... 116, 117
    - maintenance ..... 63
- C**
- Calibration ..... 113
  - coupling
    - channel ..... 56
    - trigger ..... 78
  - cursor
    - horizontal ..... 45
    - vertical ..... 47
- D**
- display
    - contents description ..... 23
    - contrast ..... 51
    - FAQ ..... 116
    - grid ..... 52
    - power-up sequence ..... 14
- E**
- EN 61010 ..... 7, 8, 122
  - EN55011 ..... 122
  - EN61000 ..... 122
  - EXT input
    - description ..... 18
    - trigger ..... 83
- F**
- FAQ ..... 116
  - fft operation ..... 75
  - frequency limit ..... 58
  - front panel ..... 18
  - functionality check ..... 15
  - fuse
    - safety instruction ..... 7
    - specification ..... 121
- G**
- GDS-2000
    - cleaning ..... 5, 7
    - feature list ..... 12
    - specifications ..... 119
  - go-no go
    - edit ..... 70
    - run ..... 73
  - GPIB
    - IEEE remote interface ..... 101
- H**
- help, built-in ..... 59
  - horizontal
    - cursor ..... 45
    - roll ..... 54
    - xy mode ..... 55
    - zoom in ..... 54
- I**
- IEEE remote

|                          |        |                             |        |
|--------------------------|--------|-----------------------------|--------|
| commands.....            | 104    | program and play            |        |
| interface.....           | 101    | edit.....                   | 76     |
| syntax .....             | 103    | run .....                   | 77     |
| image                    |        |                             |        |
| printout.....            | 86, 98 |                             |        |
| save .....               | 88, 89 |                             |        |
|                          |        | <b>R</b>                    |        |
|                          |        | rear panel .....            | 21     |
|                          |        | recall                      |        |
|                          |        | default setting .....       | 95     |
|                          |        | default setup.....          | 38     |
|                          |        | setup.....                  | 93     |
|                          |        | waveform.....               | 93     |
|                          |        | RS232                       |        |
|                          |        | IEEE remote interface ..... | 101    |
|                          |        |                             |        |
|                          |        | <b>S</b>                    |        |
|                          |        | safety                      |        |
|                          |        | guidelines.....             | 6      |
|                          |        | symbol .....                | 6      |
|                          |        | UK power cord .....         | 9      |
|                          |        | save                        |        |
|                          |        | image.....                  | 88, 89 |
|                          |        | setup.....                  | 88, 89 |
|                          |        | to memory .....             | 89     |
|                          |        | to USB.....                 | 88, 89 |
|                          |        | waveform.....               | 88, 89 |
|                          |        | setup                       |        |
|                          |        | default .....               | 38     |
|                          |        | recall.....                 | 93     |
|                          |        | recall default.....         | 95     |
|                          |        | save .....                  | 88, 89 |
|                          |        | shortcut                    |        |
|                          |        | key operation .....         | 26     |
|                          |        | menu .....                  | 29     |
|                          |        | sound configuration .....   | 59     |
|                          |        | specification               |        |
|                          |        | FAQ .....                   | 117    |
|                          |        | list.....                   | 119    |
|                          |        | storage environment         |        |
|                          |        | safety instruction .....    | 5, 8   |
| commands.....            | 104    |                             |        |
| interface.....           | 101    |                             |        |
| syntax .....             | 103    |                             |        |
| image                    |        |                             |        |
| printout.....            | 86, 98 |                             |        |
| save .....               | 88, 89 |                             |        |
|                          |        | <b>M</b>                    |        |
| math operation .....     | 74     |                             |        |
| memory length            |        |                             |        |
| configure .....          | 43     |                             |        |
| list .....               | 44     |                             |        |
| menu on/off .....        | 53     |                             |        |
|                          |        | <b>O</b>                    |        |
| operation environment    |        |                             |        |
| safety instruction ..... | 5, 8   |                             |        |
| specification.....       | 121    |                             |        |
|                          |        | <b>P</b>                    |        |
| package contents .....   | 13     |                             |        |
| PC software              |        |                             |        |
| display .....            | 98     |                             |        |
| download .....           | 97     |                             |        |
| install.....             | 97     |                             |        |
| interface.....           | 96     |                             |        |
| operation.....           | 98     |                             |        |
| power supply             |        |                             |        |
| safety instruction ..... | 7      |                             |        |
| power up sequence .....  | 14     |                             |        |
| FAQ.....                 | 116    |                             |        |
| printout                 |        |                             |        |
| directly.....            | 86     |                             |        |
| via PC .....             | 87, 98 |                             |        |
| probe                    |        |                             |        |
| attenuation.....         | 58     |                             |        |
| compensation .....       | 114    |                             |        |
| FAQ.....                 | 116    |                             |        |
| functionality check..... | 15     |                             |        |
| package contents.....    | 13     |                             |        |

|                          |     |                          |        |
|--------------------------|-----|--------------------------|--------|
| specification .....      | 121 | FAQ .....                | 117    |
| system information ..... | 60  | save file .....          | 88, 89 |
| <b>T</b>                 |     |                          |        |
| table of contents .....  | 3   | software interface ..... | 96     |
| <b>time</b>              |     |                          |        |
| date setting .....       | 61  | <b>V</b>                 |        |
| FAQ .....                | 117 | vertical                 |        |
| time setting .....       | 62  | coupling .....           | 56     |
| <b>trigger</b>           |     |                          |        |
| delay, event .....       | 83  | cursor .....             | 47     |
| edge .....               | 78  | <b>W</b>                 |        |
| pulse width .....        | 81  | waveform                 |        |
| video .....              | 80  | accumulation .....       | 50     |
| <b>U</b>                 |     |                          |        |
| USB                      |     | freeze .....             | 51     |
| configure files .....    | 91  | invert .....             | 57     |
|                          |     | recall .....             | 93     |
|                          |     | save .....               | 88, 89 |
|                          |     | vector/ dot .....        | 49     |